



This is a digital copy of a book that was preserved for generations on library shelves before it was carefully scanned by Google as part of a project to make the world's books discoverable online.

It has survived long enough for the copyright to expire and the book to enter the public domain. A public domain book is one that was never subject to copyright or whose legal copyright term has expired. Whether a book is in the public domain may vary country to country. Public domain books are our gateways to the past, representing a wealth of history, culture and knowledge that's often difficult to discover.

Marks, notations and other marginalia present in the original volume will appear in this file - a reminder of this book's long journey from the publisher to a library and finally to you.

Usage guidelines

Google is proud to partner with libraries to digitize public domain materials and make them widely accessible. Public domain books belong to the public and we are merely their custodians. Nevertheless, this work is expensive, so in order to keep providing this resource, we have taken steps to prevent abuse by commercial parties, including placing technical restrictions on automated querying.

We also ask that you:

- + *Make non-commercial use of the files* We designed Google Book Search for use by individuals, and we request that you use these files for personal, non-commercial purposes.
- + *Refrain from automated querying* Do not send automated queries of any sort to Google's system: If you are conducting research on machine translation, optical character recognition or other areas where access to a large amount of text is helpful, please contact us. We encourage the use of public domain materials for these purposes and may be able to help.
- + *Maintain attribution* The Google "watermark" you see on each file is essential for informing people about this project and helping them find additional materials through Google Book Search. Please do not remove it.
- + *Keep it legal* Whatever your use, remember that you are responsible for ensuring that what you are doing is legal. Do not assume that just because we believe a book is in the public domain for users in the United States, that the work is also in the public domain for users in other countries. Whether a book is still in copyright varies from country to country, and we can't offer guidance on whether any specific use of any specific book is allowed. Please do not assume that a book's appearance in Google Book Search means it can be used in any manner anywhere in the world. Copyright infringement liability can be quite severe.

About Google Book Search

Google's mission is to organize the world's information and to make it universally accessible and useful. Google Book Search helps readers discover the world's books while helping authors and publishers reach new audiences. You can search through the full text of this book on the web at <http://books.google.com/>

B 466052

**THE CHEMICAL EXAMINATION
OF WATER, FUEL,
FLUE GASES AND LUBRICANTS**

S. W. PARR

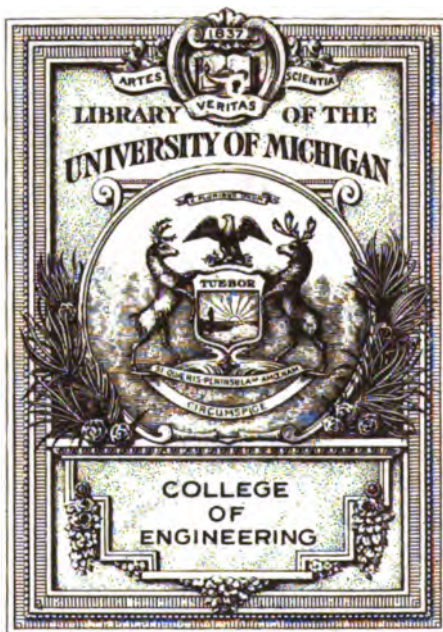

For Chemical Library

Library
TP
101
.P259cl

THE CHEMICAL EXAMINATION OF WATER, FUEL, FLUE GASES AND LUBRICANTS

A COURSE FOR ENGINEERING STUDENTS

CHEMISTRY 16

As given in the Division of Applied Chemistry at the
UNIVERSITY OF ILLINOIS

BY

S. W. PARR

Professor of Applied Chemistry

URBANA, ILLINOIS

1916

COPYRIGHT 1911
COPYRIGHT 1916
By S. W. PARR

CONTENTS

PART I:—LECTURES

	PAGE
Chapter I:—Boiler Waters:	
Source and character of mineral content.....	5
Effect of impurities.....	8
Chemical treatment.....	13
Apparatus for applying chemical processes.....	18
Rating of boiler waters.....	23
Type waters and calculated treatment.....	26
Chapter II:—Fuels:	
Types, relative values.....	27
Coal:	
Properties, Classification.....	30
Sampling.....	32
Moisture, Calculations.....	43
Unit Coal, Corrected ash.....	46
Calorimetric measurements.....	49
Table of average values.....	60
Coal specifications and contracts.....	61
Combustion, Smoke.....	65
Storage, Weathering.....	66
Chapter III:—Flue Gases, Significance of analytical results.....	71
Calculation for heat losses.....	72
Chapter IV:—Lubricants, Types, Properties.....	76

PART II:—LABORATORY METHODS

Chapter V:—Preliminary experiments.....	79
Standard solutions.....	80
Chapter VI:—Boiler water analysis.....	85
Summary and calculations.....	92
Chapter VII:—Fuel Analysis, Proximate.....	94
Heat Values, Peroxide Calorimeter.....	97
Sulphur determination.....	103
Heat values, oxygen bomb.....	108
Calculations.....	114
Chapter VIII:—Ultimate analysis.....	115
Total carbon by volume.....	117
Available hydrogen.....	119
Chapter IX:—Flue gas analysis.....	120
Chapter X:—Oil examination.....	122
Index.....	128

343012

PRELIMINARY STATEMENT

This work is intended primarily for Juniors in Mechanical and Railway Mechanical Engineering at the University of Illinois. From the chemical standpoint, it is a very serious problem to know what may profitably be attempted in the way of analytical methods in the case of students whose chemical experience is meager. But, however unsatisfactory the amount of preliminary training, it is obvious that the curriculum in Engineering courses is already overcrowded, hence the obtaining of a better prerequisite in chemistry is well nigh impossible. The work as herein outlined is the result of ten years of effort to make the most of the situation. It would be quite too much to claim that in the evolution of the work a satisfactory status has been attained. It is hoped, however, that the course will at least help the engineer to a better understanding of the literature of the topics considered and also to an appreciation and, consequently, a more intelligent use of data which may come into his hands from the chemist. It may not be out of place to state further that the course, which, at the first, was inaugurated with no little misgiving, has more than justified the experiment. For this result credit is due the students, who, from year to year have carried the work through with a responsiveness which has been the main stimulus in developing this outline into its present form.

Part I is a synopsis only of the lectures given. Part II consists essentially of laboratory directions for the analytical methods there undertaken. The time allowance for lectures, quizzes, and laboratory is nine hours per week for 18 weeks. The amount of work as outlined is such that the average student covers the ground in the time prescribed.

Special acknowledgement is due Dr. H. J. Broderson for suggested improvements in the present edition and for valued assistance in the reading of proof.

PART I

DESCRIPTIVE OUTLINE

CHAPTER I

BOILER WATERS

THEIR EXAMINATION, CHARACTER AND TREATMENT.

Water Analysis:—Waters are examined for two very different purposes. First, the object may be to determine the potability or sanitary character of the water; and, second, it may be desired to learn the behavior or value of the water for industrial uses. The requirements under each division are very different. In order to be sanitary, a water must be free from certain forms of organic matter which might indicate possible contamination with sewage or furnish a suitable breeding medium for disease germs. Within reasonable limits, the amount of mineral constituent is of little importance. On the contrary, however, the value of a water for industrial purposes depends very largely on the kind and amount of the dissolved mineral substance, while, as a rule, little importance is attached to the organic material present. This is especially true in the case of those waters which are to be used for boiler purposes, and it is this phase of the subject which is of immediate interest.

Source of the Mineral Constituents:—Natural waters in passing through the soil come in contact with certain products of decomposition and decay. Some of these substances, notably carbon dioxide, humic acid, etc., are taken up by the waters, in which condition their power to dissolve mineral matter is greatly increased. In this way the decomposition of feldspar, limestone, etc., is constantly going on, the result to the percolated water being that there is taken into solution varying quantities of silica, salts of iron, aluminum, magnesium, sodium, potassium, etc. As a rule, therefore, the less contact natural waters have had with the soil, or the more insoluble the earthy matter with which they have come in contact, the smaller will be the amount of mineral constituents dissolved: and, conversely, the deeper the source of supply, the greater the opportunity for dissolving such material, and consequently the greater will be the amount of such substances in

solution. For this reason it has been sometimes customary to divide waters into three classes:—

- First; *Surface water,*
- Second; *Shallow wells and spring waters,*
- Third; *Deep wells and artesian waters.*

Surface waters are such as are found in lakes, streams, and artificial ponds, and with these might also be considered cistern or rain waters; shallow well waters may be considered as those obtained from wells or borings which extend into the drift not to exceed 30 or 40 feet; while deep well waters may be considered those that are obtained from a depth of over 100 feet. These divisions are not sharply drawn, and, indeed, the classes merge into each other. This is more readily seen from the fact that many streams, for a large part of the year at least, are fed by waters which have their source in tile drains and springs. The system of underground drainage so largely carried on in these days, therefore, gives to the waters of smaller streams at least many of the characteristics of the water from the shallow wells. This feature is more pronounced during the dry months of the year, as, for example, in the late summer and fall. The amount of mineral matter, therefore, varies inversely as the volume of water in these minor streams. On the other hand, large bodies of water and larger streams, especially those in districts where they come in contact with the more insoluble formations, are remarkably free from mineral matter. This is especially characteristic in the waters of Lake Superior, and in many of the rivers of the north-central region of the United States. In certain regions, also, as in the delta of the Mississippi, water-bearing sands are sometimes found at very considerable depths, but with extremely small amounts of mineral matter present.

It will be seen from the above discussion that any classification based merely upon the source of a water will have little practical value. Before attempting any classification, however, based upon the character of the dissolved mineral constituents it will be necessary to review the processes by which these substances become a part of the water, and to note their properties and behavior under the conditions of actual use in steam boilers.

Chemical Characteristics of the Mineral Constituents:—Calcium carbonate, CaCO_3 , and magnesium carbonate, MgCO_3 , are the chief constituents of lime rock. Finely divided particles of these substances exist throughout all the clayey deposits of the drift region. The percolating water holding carbon dioxide, CO_2 , in solution has the property of a

weak acid, $\text{H}_2\text{O} + \text{CO}_2 = \text{H}_2\text{CO}_3$, and in this form is a solvent for the above substances, forming *bicarbonates*, thus:

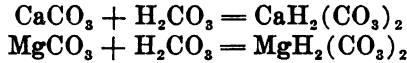

These dissolved bicarbonates are readily broken down by heat, thus:



The water alone with the carbon dioxide gas driven out of it is not a solvent for calcium carbonate, and the latter is precipitated.

Feldspars of various sorts are usually distributed throughout the drift deposits. These also are slowly decomposed by carbonated waters thereby adding to the water compounds of sodium, potassium, iron and aluminum, as well as hydrated silica, which is also soluble. The general type of this reaction may be shown, thus:

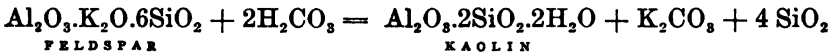

FELDSPAR

KAOLIN

In this way complex or impure rocks may, upon their decomposition, yield small quantities not only of lime and magnesium in solution as bicarbonates, but also iron in a bicarbonate form, as well as salts of sodium, potassium, and silicic acid. This result would be more readily understood if we were to enter into a study of the composition of the drift, especially of a region like this where the glacial clay has a very considerable admixture of ground rock such as feldspar, hornblend, mica, dolomite, etc. Moreover, since all drift formation has been deposited in contact with or by means of sea water, we expect a greater or less amount of mineral substances to be present due to such water; namely, sodium chloride, calcium sulphate, etc.

Solubility of Gypsum.—We are familiar with the solubility of sodium chloride, but calcium sulphate or gypsum is also soluble, although to a less degree, and this without the aid of carbon dioxide. Its solubility, for example, may be illustrated by the following table:

TABLE I

SOLUBILITY OF GYPSUM

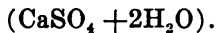

- 1 part dissolves in about 500 parts of water at ordinary temperature
- 1 part dissolves in about 1200 parts of water at 250 Degrees F.
- 1 part dissolves in about 1800 parts of water at 300 Degrees F.
- 1 part dissolves in about 3800 parts of water at 325 Degrees F.

From the above facts it may be readily understood how the mineral constituents come to be dissolved in all underground waters. The kind, amount, and properties of these substances indicate directly the behavior of a water when used for boiler purposes. Almost without exception their presence is objectionable for reasons which will be evident from the following discussion.

Effects of Impurities:—The difficulties which attend the use of water in the generation of steam are three in number:

First, *mineral scale* is formed upon the shell, flues, and sheets; second, *foaming* or *priming* may occur; and, third, the water may have *corrosive action* and weaken the metal of which the boiler is composed.

The constituents of a water, therefore, naturally group themselves under these three heads:

1. Scaling Ingredients.
2. Foaming Ingredients.
3. Corrosive Ingredients.

Scaling Ingredients: Scaling ingredients are always considered as including silica and any combination of iron, aluminum, calcium, and magnesium. Since the formation of scale is the most common and perhaps the most evident difficulty which accompanies the use of a boiler, it has sometimes been made the basis of a classification for waters. At a meeting of the American Association of Railway Chemists at Buffalo, New York, May 24, 1887, the following schedule of classification was adopted. Waters containing varying quantities of scaling material per United States gallon were graded as in the table below:

TABLE II
CLASSIFICATION OF WATERS BY THE
ASSOCIATION OF RAILWAY CHEMISTS

Below 8 grains.....	very good
8 to 15 grains.....	good
15 to 20 grains.....	fair
20 to 30 grains.....	poor
30 to 40 grains.....	bad
over 40 grains.....	very bad

In this table the first line was added by the C. B. & Q. Ry. to fit the case of Lake Michigan water, which has approximately 8 grains or less per gallon.

This classification is relative only, since a wider study of the subject has indicated the necessity of taking into the account the kind of scale which would form and the other ingredients in addition to those which produce scale. The scale when formed, may be dense and flint-like or open and porous. These characteristics result from the various types of mineral content involved. In general, a hard, flinty scale is due to the presence of calcium or magnesium sulphates; while, in waters in which only the carbonates of these substances are present, the scale will be more open and friable. Indeed, a very large number of waters are met with where only carbonate hardness is present. In these cases the major part of the incrusting solids appears as mud or sludge. For these and other reasons the above classification has not met the needs of the case and has, indeed, not been adopted to any considerable extent. A much more practical classification would take account of all of the various constituents and the characteristics for which they are responsible. The method of classification devised by the Chicago, Burlington & Quincy Railroad is based on the amount of these various constituents. Since the full meaning of the same can be better understood later, it is reproduced at the end of this chapter.

Effect of Scale.—Boiler scale is a disadvantage for the reason that: First, it retards the transmission of heat; second, it promotes the formation of a high temperature in the plates, with a possibility of softening the same; third, the sudden rupture or opening up of the scale may admit water to the highly heated metal, forming hydrogen and oxygen; fourth, the higher temperature of the steel thus maintained, even though not reaching the danger point, promotes the absorption of sulphur and oxygen and thus causes a deterioration of the metal. Doubtless the chief item in this list, by reason of its continuous and total aggregate effect, is the decrease of heat conductivity, requiring a larger amount of fuel. Authorities differ as to the extent of loss. A conservative estimate would place the loss of fuel at 10% for each 1/16 of an inch in thickness of the scale. The difficulties attending the estimation of the fuel loss are great, and it is to be expected that a rather wide range of results is found in the published data.*

A test of the steaming efficiency, made upon an Illinois Central locomotive by the University of Illinois in 1898 and described in the *Railway Gazette* for the following year, indicated a loss of heat, with a

*The effect of scale on the Evaporation of a Locomotive Boiler. By L. P. Breckenridge. *R. R. Gazette*, Vol. 31, new series, p. 60, 1899.

Am. Ry. Eng. Assn., 1914, p. 692: "———— it is concluded that the saving of \$977. per locomotive represents 7 cents per pound of excess scaling matter entering the boiler ———".

Bulletin No. 11, Eng. Exp. Sta., U. of I.

Am. Ry. Eng. & Maint. of Way Assn., Jan., 1907, p. 41, etc.

scale averaging $3/64$ " in thickness, amounting to 9.6 per cent. The same engine was tested before overhauling at the shops and was returned after cleaning for the comparative test. An interesting computation was made on the same road at a much earlier date, in which the performance sheets for 120 locomotives were taken with reference to the consumption of coal before overhauling, and these results were compared with the coal consumed for the three months immediately following such a cleaning, with an average for the 120 engines of almost exactly 10 per cent in favor of the scale-free condition. Many other tests have subsequently been made more or less confirmatory of these results.

Foaming Ingredients:—The non-scaling or foaming ingredients are considered to be the salts of the alkalies, such as sodium chloride, sodium sulphate, sodium carbonate, potassium chloride, potassium sulphate, potassium carbonate, etc. Other conditions contribute to the tendency of water to foam, such as the presence of organic matter, especially such substances as may form soap. The presence of finely divided solids in suspension is also a contributing cause.

The objections against foaming may be stated as follows: First, the rising of the water in the gauge glass or blow off cocks makes it difficult, if not impossible, to know the height of the water in the boiler; second, the discharge of wet steam or of steam carrying a considerable quantity of water is exceedingly wasteful of heat and makes it difficult to keep up the steam pressure; third, there is danger of large quantities of water getting into the cylinders where, by reason of its incompressibility and inability to pass quickly out of the ports, a cylinder head may thereby be blown off; and, fourth, the grit carried along with the water promotes the cutting of the walls of the cylinders and valve seats, thus making a re-boring of the cylinders necessary.

Concerning the causes which promote foaming, they are not so easy to define or classify as in the case of scaling, and they do not always relate directly to the character of the dissolved mineral substance. The tendency to foam varies greatly, for example, with the two general types of boilers employed, those used for stationary purposes, and the locomotive type. It might be said, indeed, that to the above mentioned conditions of the water might be added the nature of the spaces in which the generation of steam takes place. A net-work of stay-bolts and braces in a steaming space of small volume at best will be more conducive to foaming than the opposite conditions. The structure and steaming capacity of the locomotive, therefore, greatly increase the tendency of this type of boiler to foam. Tests on numerous railroads pretty generally agree upon the following facts concerning the foaming in loco-

motives. When a density of the water due to the presence of alkali sulphate or chloride reaches approximately 100 grains to the gallon, foaming is apt to occur, especially when the engine is put under heavy work. This means that in the raw water, before condensation has been carried on, a content of 25 grain per gallon would reach the foaming stage when 3 or 4 tankfuls had been taken into the boiler. However, a wide variation is due to the type of foaming ingredients, since a less amount of alkali salt will cause foaming where part of the substance is alkali carbonate, Na_2CO_3 , or soda ash. Where much organic matter also is present, a still less amount of free alkali will cause foaming. Indeed, cases have been met with where 15 to 25 grains per gallon of alkali salts have produced foaming, when one-half, for example, of such salts were in the form of alkali carbonates, accompanied by a very considerable amount of organic matter. Foaming in stationary boilers would scarcely be caused by double the amount mentioned above.

Corrosive Ingredients:—Much disagreement exists regarding the causes of corrosion. Certain conditions will produce galvanic action between different metals used in construction, or even between different parts though made of the same metal, and this action eats away the metallic surfaces. Flaws, cinder scales, oxide nodules, etc., will, probably for a similar reason, produce pitting. Along sharp angles of construction, where the metal has been put under strain, corrosion will frequently occur. Carbonic acid gas or oxygen, when dissolved in water, are solvents for iron. Of course, the heat soon drives these gases out of the water, but corrosion in the vicinity of the feed inlet may be due to this cause. Some waters percolate through culm heaps or coalmine refuse or drainage and have produced in them free sulphuric acid from the oxidation of iron pyrites, or they may take up sulphate of iron or aluminium, all of which chemicals render a water positively and vigorously corroding.

Nitrates are seldom encountered, but, when present in any considerable amount, are strongly corroding. Calcium and magnesium chlorides are also strongly corroding. But, after all, it may be noted that many conditions can exist to neutralize the corrosiveness of a water. For instance, there may be formed a hard, dense scale which will effectually protect the iron. In this case, however, we would expect to see some tendency toward corrosion and pitting under the scale.

If, now, we attempt to classify waters according to the mineral constituents above outlined, we would have:

Class I.—This class includes such waters as have present free sodium carbonate or more than enough sodium to unite with the sulphate,

chloride, and nitrate radicals or ions. There would be left, therefore, only carbon dioxide, CO_2 , to unite with the remaining sodium and also the calcium, magnesium, and iron. Such waters have only *temporary hardness*, there being no sulphates of calcium or magnesium. Upon boiling or using in the steam boiler, only a sludge forms instead of scale. The carbonates are all in the bicarbonate form and, hence, are stable in the cold, but decompose upon heating. Waters of this class are very widely distributed throughout the drift region, and the source is usually from deep wells.

Class II.—The waters of this class contain calcium or magnesium sulphate as well as bicarbonates, but not the chlorides of these elements. They have, therefore, permanent hardness and form a hard, flinty scale. Such waters are usual in surface supplies and in most shallow wells.

Class III.—This includes such waters as contain corroding salts or free acid in solution, such as the chlorides or nitrates of magnesium or calcium, the sulphate of iron or free sulphuric acid. Such waters are infrequent but, because of their corroding character, should be recognized when met with.

The Chemical Treatment of Boiler Waters:—From what has preceded it will be readily understood that the treatment of boiler waters must follow closely along the line of the chemical character of dissolved ingredients, with a view also to the properties which various ingredients impart to the water. In the first instance, it must be remembered that all natural water is strongly impregnated with carbon dioxide. We should recall again the fact that the presence of this gas in the water has furnished a solvent condition which has resulted in the formation of bicarbonates, especially of lime, magnesium, and iron.

But other soluble substances, we have already seen, also enter into the water, notably the sulphates of lime, magnesium, sodium, etc. Now, because of the fact that the compounds of the first group of substances are easily decomposed by heat and thus discharged from solution, we have a sub-division of scaling ingredients into

(A) Those which are designated as constituting *temporary hardness* and (B) Those which constitute *permanent hardness* of water. The first division is present in all waters and includes the larger part of the scaling matter; the latter is variable in amount and frequently absent, so far as the scaling constituents are concerned. These two general divisions or types of scaling material must be borne in mind, because they form the basis of all practical methods for water treatment, indeed, each division represents a process or a method which must be followed

for the removal of these substances. This may be more clearly illustrated by the following outline:

TABLE III
SCALING MATTER AND TREATMENT

Scaling matter is principally composed of	{	Div. I. Bicarbonates as:—	{	“Excess” CO ₂	For this Div. use	{	CaH ₂ (CO ₃) ₂	Ca(OH) ₂ .	CaCO ₃ +2H ₂ O
		Mg	“	The results are	MgCO ₃ +CaCO ₃ +2H ₂ O				
		Fe	“				FeCO ₃ *+CaCO ₃ +2H ₂ O		
		Div. II. Sulphates as:	{	MgSO ₄	For this Div. use	{	Ca	Na ₂ CO ₃ .	MgCO ₃ +Na ₂ SO ₄
		Fe	“	The results are	CaCO ₃ +Na ₂ SO ₄				
							FeCO ₃ *+Na ₂ SO ₄		

*This substance quickly breaks down into Fe(OH)₃ thus:

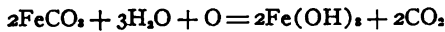

It will be readily seen from this outline that the first division, carrying the bicarbonates, may be removed from the water either by heat or by the addition of some chemical which will absorb the “excess” and “bicarbonate” carbon dioxide. If we were to depend upon heat for this work, it would be a long process for the reason that ordinarily these bicarbonates are not completely broken down except upon rather prolonged boiling, say for 15 or 20 minutes or even 1/2 hour, and this again would indicate the impracticability of such a method, because of the expense involved.

Treatment with Lime, Ca(OH)₂:—Since hydrated lime reacts at ordinary temperatures and, moreover, is the least expensive of the possible reagents, it is made use of to react with the CO₂ of Div. I of Table III.

In measuring the amount of Ca(OH)₂ needed for treating a water, it must be borne in mind that the CO₂ dissolved as H₂CO₃ will react with the Ca(OH)₂ the same as the bicarbonates. Hence we have a series of reaction thus:

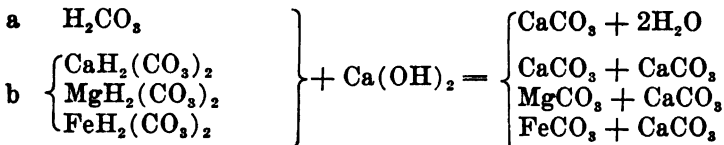

The total CO_2 to be thus taken care of is designated as (a) "excess" or "free" carbon dioxide, and (b) "half bound" or "bicarbonate" carbon dioxide. It is necessary to measure the amount of free carbon dioxide by titrating, say 200 c.c. of the water with $\text{N}/_{50}$ Na_2CO_3 , using phenolphthalein as indicator. Each c.c. of this reagent, therefore, represents an equivalent of 0.001 gram in terms of CaCO_3 .*

Therefore, 5 times the number required for 200 c.c. of water would represent the equivalent in 1000 c.c. or 1 liter of water. This would represent milligrams per liter which is the same as parts per million. Parts per million multiplied by 0.0583 = grains per gallon.**

The "bicarbonate" carbon dioxide is determined by titrating a measured volume of the water with $\text{N}/_{10}$ sulphuric acid, using methyl orange as indicator. (See p. 86, Part II.) Each cubic centimeter of $\text{N}/_{10}$ sulphuric acid is equivalent to 0.005 gram CaCO_3 . Therefore, if 200 c.c. of water be titrated, each c.c. of acid used corresponds to 0.025 grams, that is 25 milligrams per liter or 25 parts per million bicarbonate carbon dioxide, *measured in terms of CaCO_3 .*

The above estimation of the "free" and "half bound" carbon dioxide would represent all of the conditions to be taken into consideration in connection with the lime treatment except for the slight irregularity in the behavior of one element. The magnesium carbonate, especially in the presence of other salts, is soluble to an extent which makes it advisable to carry the reaction one step further and provide for the formation of magnesium hydroxide which compares favorably as to insolubility with the calcium carbonate. This is effected by adding enough extra $\text{Ca}(\text{OH})_2$ to correspond to the magnesium present. By direct determination, therefore, of the magnesium and the calculation of the same to the calcium carbonate equivalent, we have the necessary correction indicated for this element. By adding the calcium carbonate equivalent thus found to the factor as derived above by titration with $\text{N}/_{10}$ sulphuric acid, we have a corrected calcium carbonate equivalent for the bicarbonate carbon dioxide plus the magnesium present.

Having thus determined the amount of "excess" and "half bound" carbon dioxide plus the magnesium, in terms of CaCO_3 , the amount of reagent as CaO for the total CaCO_3 equivalent would be in the ratio of 56 : 100. To transfer to a unit of 1000 gallons, multiply values for 1 gallon by 1000; and to transfer grains to pounds avoirdupois, divide

*The molecular weight of CaCO_3 is 100. This is a bivalent molecule, hence the univalent or hydrogen equivalent would be 50, and the $\text{N}/_{50}$ value would be 1 gram per 1000 c.c. Hence 1 c.c. would have a CaCO_3 equivalent of 0.001 gram.

**One gallon weighs 58330 grains hence $1/1,000,000$ of a gallon or 1 part per million weighs .0583 grains.

by 7000. Hence, $1/7$ of $56/100$ or .08 times the grains per gallon of total calcium carbonate equivalent represents the pounds of CaO reagent needed for each 1000 gallons of water in removing or correcting for these ingredients.

In the case of common or commercial reagents used in water treatment, the impurities, of course, must be allowed for.

Where the lime is added in the form of a clear solution of $\text{Ca}(\text{OH})_2$, the latter is dissolved to the point of saturation and this concentrated solution becomes the reagent.

The solubility of CaO is about 78 grains per gallon cold, (60°F). Hence $1/78$ th gallon of *lime water* contains 1 grain of CaO, and $\frac{7000}{78}$ would represent the number of gallons necessary to hold 1 pound of CaO in solution. Therefore,

$$\frac{7000}{78} \times \frac{100}{8} \text{ or } 7.17 + \begin{array}{l} \text{The grains} \\ \text{per gallon} \\ \text{of CaCO}_3 \\ \text{equivalent} \end{array} = \begin{array}{l} \text{No. gals. of sat. lime} \\ \text{water required to remove} \\ \text{the total calcium carbon-} \\ \text{ate equivalent in 1000} \\ \text{gallons of water.} \end{array}$$

The solubility of CaO decreases as the temperature of the water increases. It should be remembered, also, that CaO slakes to $\text{Ca}(\text{OH})_2$ and it is really the solubility of the latter compound which is involved. Usually, however, the reference is made to the solubility of CaO as the basis. Thus, by calculating from Lamy's tables (C. R. Vol. 86, p. 333),

- 78 grains CaO will saturate one U. S. gallon at 60°F .
- 70 grains CaO will saturate one U. S. gallon at 86°F .
- 58 grains CaO will saturate one U. S. gallon at 112°F .
- 51 grains CaO will saturate one U. S. gallon at 140°F .
- 33 grains CaO will saturate one U. S. gallon at 212°F .

Recently the market has come to be supplied with pulverized dry lime in the hydrated form. To find the solubility by weight of this material, calculate the above amounts to the equivalent of $\text{Ca}(\text{OH})_2$. Thus,

$$\begin{array}{ccccccc} 56 & : & 74 & :: & 78 & : & x \\ \text{CaO} & & \text{Ca}(\text{OH})_2 & & \text{gr. CaO} & & \text{gr. Ca}(\text{OH})_2 \end{array}$$

Whence, 78 grains CaO = 103 grains $\text{Ca}(\text{OH})_2$, which would represent the solubility per gallon at 60°F . of pure material.

Treatment with Soda Ash, Na_2CO_3 .—Of the substances sufficiently cheap to be available, sodium carbonate or "soda ash" is by far the

best adapted for division II of Table III, or those ingredients causing the permanent hardness of the water. No reaction or change in solubility by heating can be effective, though many attempts to remove the sulphate by reason of the less solubility of calcium sulphate in hot water, (as indicated in Table No. I), have been attempted. With this class of substances, it is more effective to remove them as carbonates, but this must be brought about by the addition of a soluble carbonate salt, the cheapest of which is sodium carbonate or "soda ash", Na_2CO_3 , as above indicated.

To measure the amount of "soda ash", Na_2CO_3 , necessary for the precipitation of the sulphates of magnesium, calcium, and iron or permanent hardness, read carefully paragraph IV on page 87 of Part II.

The reactions involved may be represented as follows:

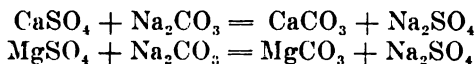

The amount of "soda ash" used up in this reaction is directly the measure of this substance to be used in treating the water. Thus:—If 200 c.c. of water were taken, then 5 times the number of c.c. of $\text{N}/_{10}$ $\text{Na}_2\text{CO}_3 \times 0.0053$ would represent the weight in grams per liter of Na_2CO_3 required. This multiplied by 1000 = milligrams per liter and this multiplied by 0.0583 would give the grains per gallon required directly in terms of "soda ash". Multiplying this by 1/7 would give the number of pounds needed per thousand gallons. Where magnesium salts are present as part of the permanent hardness, the MgCO_3 formed as indicated above is to be precipitated as $\text{Mg}(\text{OH})_2$, the same as under temporary hardness. Hence, all magnesium compounds call for an equivalent of $\text{Ca}(\text{OH})_2$ in addition to the primary reagent needed. This, however, is provided for in the method of analysis which determines all of the magnesium, whatever the form in which it is present; and the secondary reagent, $\text{Ca}(\text{OH})_2$, for its removal has been considered under the preceding topic; viz., "Treatment with Lime". A double reaction is thus provided for magnesium, whether the combination be that of a bicarbonate, a sulphate, or a chloride.

Industrial Methods:—While in this discussion the reactions involved in the purification of water have been considered separately and as two distinct processes, in practice they are combined into one operation; that is, the calculated amount of lime for treating, say, 1000 gallons of raw water has incorporated with it the amount of soda ash as indicated by the sulphate or permanent hardness per 1000 gallons, and the two reagents thus combined are added directly to the water.

Very many mechanical devices for automatically measuring the correct amount of each reagent are in use, depending in the main upon

the principle that a given weight or volume of the incoming raw water shall operate certain mechanical arrangements, whereby the proper amount of chemical is discharged into the water. The devices are of two general types:—the continuous and the intermittent. In the continuous type the raw water flows into the apparatus and is discharged in the purified form ready for use. In the intermittent type the raw water is made to flow through a mechanical measuring arrangement, whereby the chemicals in the proper proportion are added, after which the water is brought into a large settling tank for the time element to enter in for the accomplishing of the reaction involved and also the settling out of the precipitates. Both types are effective, the essential point in any case being that the automatic devices for measuring the reagents be exact and unfailing in their operation. Illustrations are given below of representative devices* for each type. They have been selected primarily with reference to their adaptability in the matter of illustrating the principles of water treatment as outlined in the text.

Arguments are plentiful for the adoption of some form of water purification for practically every sort of industrial use. For domestic and laundry purposes the softening of the water supply by means of the soap employed is, theoretically at least, far more expensive than doing the same work with soda-ash and lime. The various railway systems for the most part make use of purification plants for their service waters. One company with 34 treating plants on its various lines shows a summary for 1915 as follows:*

Total consumption treated water.....	604,468,087 gallons
Total scaling material removed by treatment..	1,816,837 pounds
Saving in fuel, repairs, etc., estimated at 7c per pound of incrustants removed.....	\$127,171.00
Cost of treatment, Labor, Chemicals, Maintenance, plus 10% on investment.....	26,017.00
	<hr/>
Total net saving	\$100,454.00
Cost of 34 treating plans.....	70,450.00

*Communicated by R. C. Bardwell, Chief Chemist, Union Pacific Ry., K. C.



FIG. 1 EUREKA WATER SOFTENER, CONTINUOUS SYSTEM, AS SUPPLIED BY DODGE MANUFACTURING CO., MISHAWAKA, IND.

The description of the parts can be seen from the explanation accompanying Fig. 2.

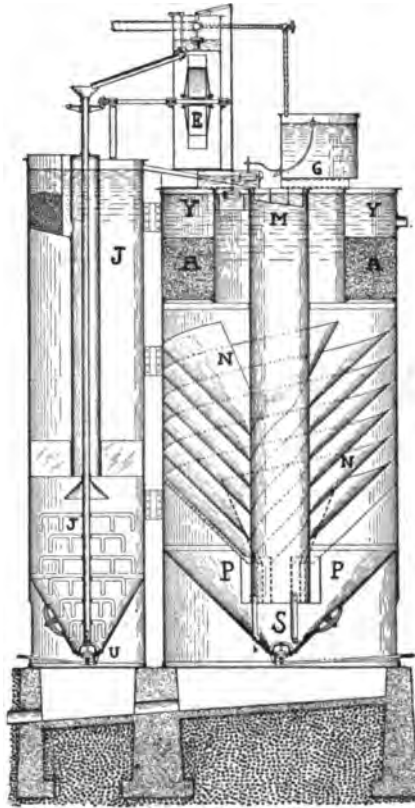

FIG. 2 CONTINUOUS WATER PURIFICATION APPARATUS.—DODGE MANUFACTURING Co., MISHAWAKA, INDIANA.

- | | |
|--------------------------|-------------------------------------|
| A—Wood fiber filter | M—Reaction chamber |
| B—Raw water inlet tank | N—Spiral accelerator plates |
| E—Overshot water-wheel | P—Sludge catchers |
| G—Soda ash solution tank | X—Gravity overflow of treated water |
| J—Lime saturating tank | Y—Treated water reservoir |
| S and P—Flushing valves | |

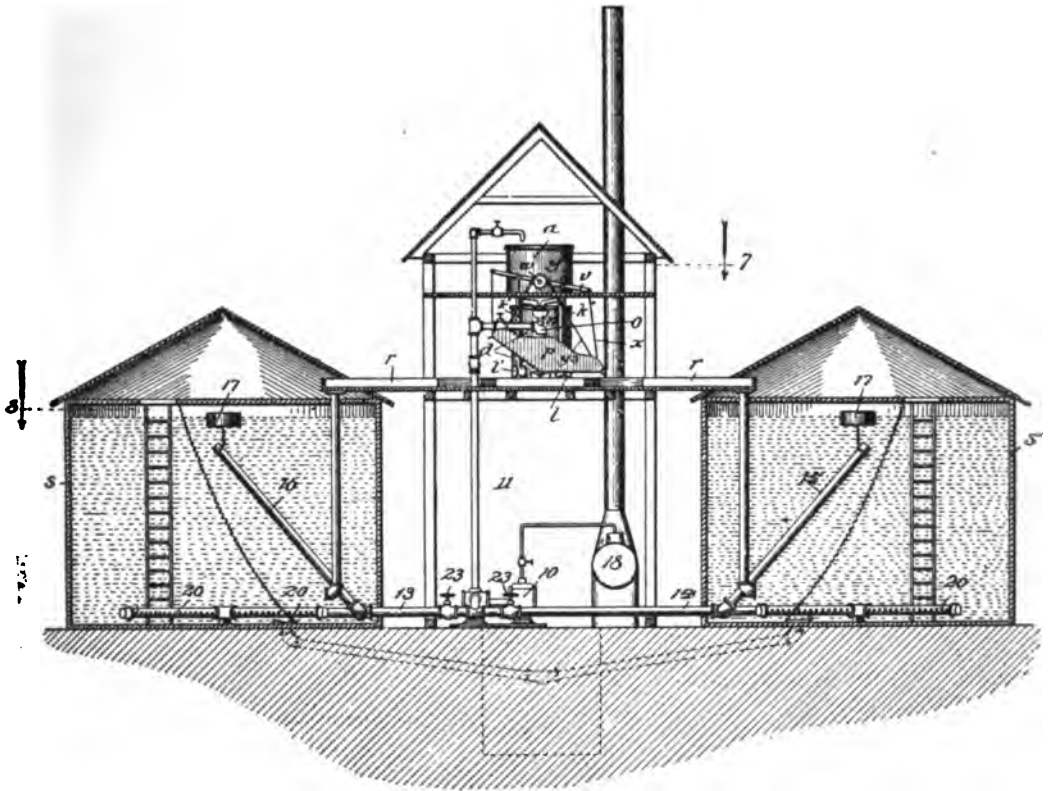

FIG. 3 INTERMITTENT PURIFICATION SYSTEM, AS USED BY THE CHICAGO & NORTH-WESTERN RY. CO.,—DEvised BY G. M. DAVIDSON, CHEMIST AND ENGINEER OF TESTS, C. & N-W. RY. CO.

The pump house is located between two tanks. The raw water, together with the chemical mixture, is delivered into the tilting vessel, "P", from which it is discharged to the right or left into the wooden box or trough "r" and "r¹". These troughs are provided with shut-off gates, so that the treated water may be delivered entirely into one tank or the other.

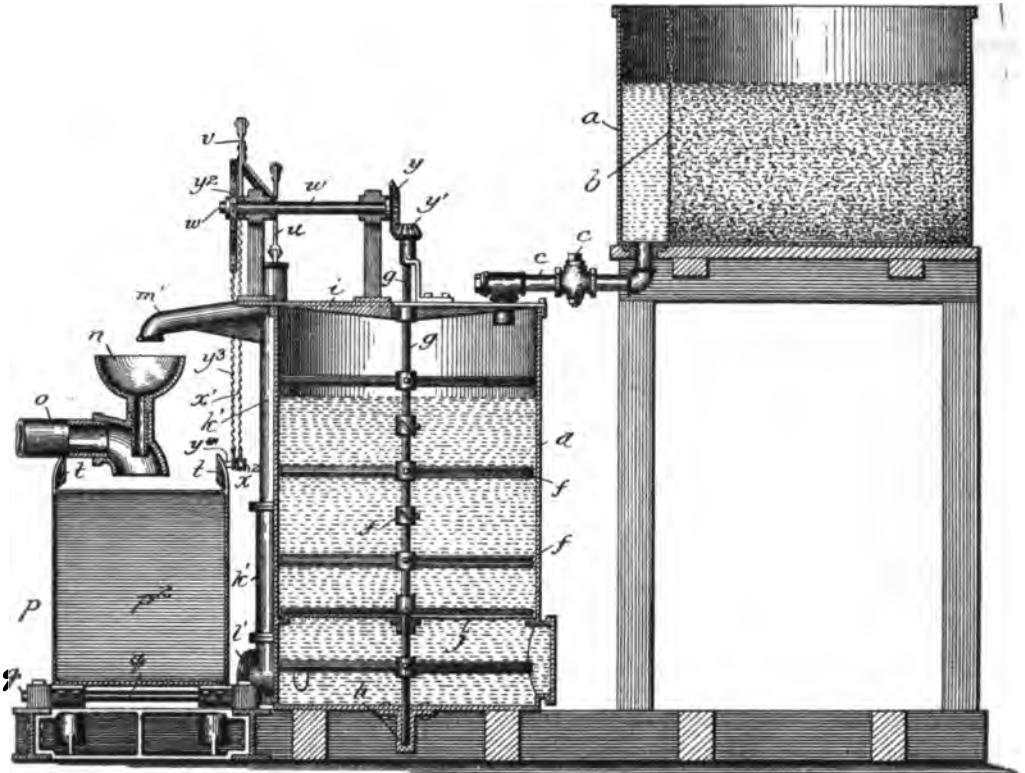

FIG. 4 CHEMICAL MIXING AND MEASURING DEVICE.

The chemical is delivered through the funnel "n", together with the raw water, passing through the pipe "o" into the tilting vessel "P".

Designed by G. M. Davidson, Chemist and Engineer of Tests, Chicago & Northwestern Ry. Co.

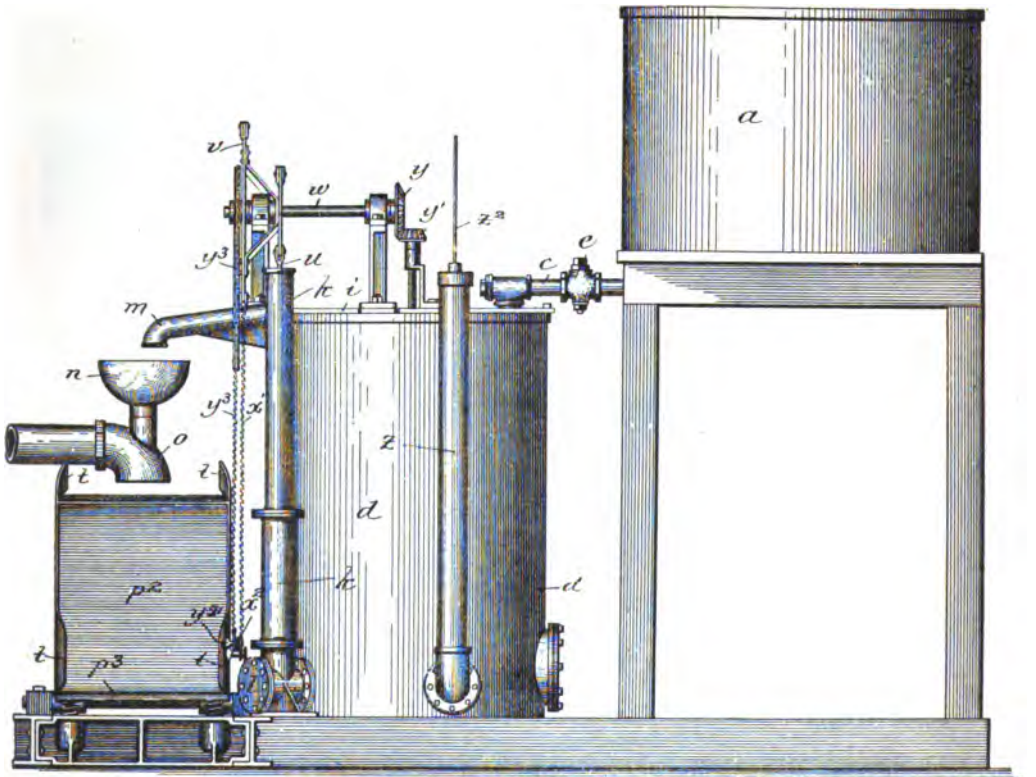

FIG. 5 CHEMICAL MIXING AND MEASURING DEVICE.

Showing the measuring pump "k", which is actuated by walking beam attached to shaft "w", discharging the measured quantity of chemicals through the pipe "m" into the tilting vessel "p". The standpipe "z" is for indicating the depth of the chemical solution remaining in tank "d".

Devised by G. M. Davidson, Chemist and Engineer of Tests, Chicago & Northwestern Ry. Co.

TABLE IV

RATING OF BOILER WATERS
As made use of by the C. B. & Q. R. R.
W. H. Wichorst, Engineer of Tests.

Incrusting Rating.

The figures represent parts per 100,000

1. Very Good—Water having sodium carbonate, and hardness less than 35.
2. Good —Water having sodium carbonate, and hardness greater than 35.
Water having sulphate hardness less than 5, or total hardness less than 20.
3. Fair —Water with sulphate hardness between 5 and 10, and total hardness less than 30, or total hardness between 20 and 30.
4. Bad —Water with sulphate hardness between 10 and 15, and total hardness less than 50, or total hardness between 30 and 50.
5. Very Bad —Water with sulphate hardness greater than 15, or total hardness greater than 50.

Foaming Rating.

- A. Very Good—Alkali salts less than 7.
- B. Good —Alkali salts between 7 and 15.
- C. Fair —Alkali salts between 15 and 25.
- D. Bad —Alkali salts between 25 and 40.
- E. Very Bad —Alkali salts over 40.

Summary of Ratios:—In the preceding discussion the various scaling ingredients have all been reduced to the CaCO_3 equivalent, chiefly for convenience in making calculations for the amount of reagent needed in treatment. If, however, we have in hand the analysis of a water giving the hypothetical combination as the various ingredients are supposed to occur in the water, it will be found more convenient to make use of a table of factors, as given below. This, in the main, has been compiled from the Report of the Committee on Water Service of the American Railway Engineering and Maintenance of Way Association, embodied in their Bulletin No. 83, January, 1907. See also "The Hard-

ness of Illinois Municipal Water Supplies," by Dr. Bartow, Proc. Illinois Society of Engineers and Surveyors, 1909.

TABLE V

SHOWING THE RATIO OF REAGENT TO INCRUSTING MATERIAL REQUIRED FOR WATER TREATMENT.

Wt. of 1 U. S. gallon of water at 65°F.....58,330 grains

1 part : 1,000,000 :: x : 58,330

Hence, x grains per gallon = 0.05833 × parts per million.

I part free CO ₂	requires	1.27 parts	CaO	and leaves no foaming material
I " Na ₂ CO ₃	"	0.53 "	CaO	" " 1 part "
I " CaCO ₃	"	0.36 "	CaO	" " no " "
I " CaSO ₄	"	0.78 "	Na ₂ CO ₃	" " 1.04 " "
I " CaCl ₂	"	0.96 "	Na ₂ CO ₃	" " 1.05 " "
I " MgCO ₃	"	1.33 "	CaO	" " no " "
I " MgSO ₄	"	0.88 "	Na ₂ CO ₃ +0.47 pts. CaO	" " 1.18 " "
I " MgCl ₂	"	1.11 "	Na ₂ CO ₃ +0.59 pts. CaO	" " 1.22 " "
I " acid (H ₂ SO ₄)	"	0.57 "	CaO+1.08 pts. Na ₂ CO ₃	" " 1.45 " "

Standards for indicating Degrees of Hardness:—The English degrees of hardness on Clark's scale as it is usually called, represent grains per Imperial gallon; that is, each degree is one part per 70,000. Hence 1 degree of hardness by the Clark scale would be $\frac{70,000}{58,330}$ or 1.2 degrees per U. S. gallon.

It is usual in this country to refer hardness as well as the other values to parts per million, although the French unit is sometimes used, wherein the reference is to parts per 100,000.

TABLE VI
RELATIVE VALUES FOR DEGREES OF HARDNESS

	Grains per U. S. gallon	Grains per Imperial gallon	French unit or parts per 100,000	U. S. unit or parts per 1,000,000
1 part per 1,000,000	0.058	0.07	0.10	1.00
1 degree Clark's scale	1.20	1.00	1.43	14.30

Limits of Purification:—It should be borne in mind that at ordinary temperatures the precipitated material is soluble to the extent of 3 to 5 grains per gallon. Hence, this represents the approximate limit to which scaling matter can be removed. At higher temperatures the solubility, especially of the magnesium product, is greatly reduced. So that, if it were practicable to raise the temperature of the water for treatment 50°F, the residual scale forming material could be reduced to 1 or 1.5 grains per gallon.*

Typical Waters and Their Treatment:—In the Table below is given the composition of a number of typical waters from municipal supplies in Illinois, together with the calculated amounts of the reagents called for and the cost of the same calculated on the basis of lime at \$6.00 per ton and soda ash at \$6.00 per 100 pounds.**

*"Water Softening", W. A. Powers, Chief Chemist, Santa Fe Railway.

**From Hardness of Municipal Water Supplies. Dr. Bartow, Proc. Ill. Soc. Engineers and Surveyors 1909.

TABLE 3—TABLE SHOWING THE HARDNESS AND THE AMOUNT OF LIME AND SODA ASH REQUIRED TO SOFTEN THE WATER FURNISHED TO A NUMBER OF ILLINOIS MUNICIPALITIES.

CITY	Class	Resi- due	Mineral Content—Parts per Million					Soda Ash		Lime			Cubic Feet of lime per 1000 Gallons of water softened	REMARKS			
			Na ₂ CO ₃	MgCl ₂	MgSO ₄	MgCO ₃	CaSO ₄	CaCO ₃	Parts per Million	Grains per Gallon	Lbs per 1000 Gallons	Parts per Million			Grains per Gallon	Lbs per 1000 Gallons	
Amboy	I	389	14.1	125.2	285.	16.4	2.38	-.00714	(Clay and Silic- ious matter 108.5 Av of 8 analyses of different wells. Artesian well. Spring. (a) U. S. G. S. Deep well. (Mixture of deep & shallow wells. Average for south- ern end.	
Atlanta	I	517	46.8	154.6
Aurora	II	468	35.4
Beardskovn	II	378	65.0
Belvidere	II	852	1.6
Bloomington	II	810	436.2
Byron	II	298	4.0
Cairo	II	285	7.3
Cambridge	I	1052	49.0	68.6
Canton	II	1620	205.
Carbondale	I	1818	244.0	48.0
Carrollton	I	3171	289.0
Champaign	II	318	4.8
Charlestarh	I	408	56.0	101.0
Charlestarh	I	702	124.3	191.5
Channahon	II	281	88.0
Danville (a)	II	293	24.5
Decatur (a)	II	1087	158.5
Dwight	II	1287	88.0
East St. Louis	II	283	8.5
Edinburgh	II	257	38.4	
Elgin (a)	II	280	30.0	
Elgin	I	347	63.0	88.	
Farmer City	I	719	255.1	85.0	
Freeport	II	468	62.0	
Galesburg	II	951	135.1	
Harvey	II	1204	289.7	
Havana	II	196	15.5	
Minok	I	2226	872.8	14.6	
Normal	I	410	168.	88.	
Ottawa	I	398	69.7	95.2	
Polo	II	867	8.6	
Rantoul	I	357	88.0	112.4	
Springfield	II	376	21.0	
Streator (a)	II	325	61.0	69.0	
Tolono	I	656	277.4	104.9	
Urbana	I	408	56.0	101.0	
Lake Michigan	II	140	7.3	

CHAPTER II

FUEL

Introduction:—Motion, industrially considered, is a commodity which, when available in proper form and in sufficient quantity, is designated as power.

The sources of motion are two in number :—

- (1) Gravity
- (2) Chemical Action.

Gravity is transformed into motion through the medium of falling water; and to a smaller extent by means of wind currents.

Chemical activity may be derived from the world's fuel supply in greater amount and at less cost than from any other source.

By the burning of fuel, chemical action may be made to transfer its motion through the medium of steam or, to a smaller extent, as in the internal combustion engine, directly and without any medium, to the working parts of machinery. Proximity to fuel beds, therefore, or accessibility by reason of shipping facilities is an index of present or potential activity along industrial lines. Hence, it is evident that the fundamental purpose of the industrial examination of fuels is to correctly measure the amount of chemically active material which resides in a given sample. This may be determined in two ways: First, by analytical methods wherein the amount of inorganic or chemically inactive substance is determined, as distinct from the organic or chemically active material; and, second, by actual combustion whereby the fuel is made to indicate its activity by the evolution of heat, the quantity of which may be measured.

Types of Fuel:—For convenience in discussion, fuels are divided into solid, liquid, and gaseous types. This classification with further subdivisions may be shown in tabulated form as follows:

FUELS	{	Solid	{ Wood Coke and Charcoal Coal
		Liquid	{ Alcohol Distillates Petroleum
		Gaseous	{ Natural Gas House Gas Producer Gas

Wood:—By reason of the high cost of wood it is rapidly passing out of the list of available fuels. While its content of inactive substance in the form of ash is low, its content of free moisture is high, even in

seasoned wood, and together with combined water constitutes more than half of the wood by weight. Its activity, therefore, measured as heat is only about half that of good coal averaging 6,000 or 7,000 British thermal units per pound. Since a cord of hard wood weighs approximately 4,000 pounds, that amount is about equal in heat value to a ton of coal.

Coke.—Coke is at present chiefly a fuel having special properties which make it suitable for metallurgical purposes. It has very little inactive material except the ash, which is always of higher percentage than in the coal from which it is made. Measured in terms of heat units, coke is equal to the average anthracite coal.

Coal.—Coal is by far the most abundant and cheapest of all fuels. It varies in character from the hard, rock-like anthracites to the soft lignites. The inert non-active substances in the form of water and ash vary from 8 per cent to 40 per cent, and are inversely related to the quantity of heat available. Since these factors are fundamental in the commercial estimation of values, classification, etc., of coal, they will be discussed under the more general treatment of coal which is taken up later.

Alcohol.—Alcohol is a prospective rather than a present source of fuel energy. It has no ash but a large percentage (34.8% of combined oxygen, which approximately represents the inert material. Its heat value in pure form is 12,391 B.t.u. per pound. It is denatured usually by adding about one-third of one per cent of kerosene to render it unpalatable and approximately ten per cent of methyl or wood alcohol to make it poisonous and not easily purified by redistilling. About ten per cent of water is usually added for use in gas engines. Other permissible formulas are given in United States Department of Agriculture, Bureau of Chemistry Bulletin No. 130.

Distillates.—The petroleum distillates are hydro-carbon compounds and are almost entirely free from inactive material. Their heat value varies with the specific gravity, which directly is a measure of the ratio of carbon to hydrogen. The lighter the distillate the higher the ratio of hydrogen and, consequently, the higher the heat value, which may vary from 19,000 to 22,000 B.t.u. per pound.

Petroleum.—Chemically considered, petroleum is substantially the same as distillates but, being heavier, has a lower heat value, ranging from 18,000 to 20,000 B.t.u. per pound. Crude petroleum varies in character, some districts yielding heavier and some lighter oils. Petroleum residues have had the lighter oils removed by distillation. These residues are of higher specific gravity and lower heat value.

Gases.—Gases are more or less mixed with inert material and, when measured with reference to their chemical activity in the form of heat,

the values are referred to a cubic foot at 60°F. temperature and a pressure of 30 inches of mercury, as representing the average or standard temperature and pressure of the atmosphere. Because of the inevitable tendency for all forms of this material to have an admixture of inert gases, the heat values are very variable. Their character may, however, be expressed in a general way as follows:

Natural Gas is usually composed in large part of methane or marsh gas, which in pure form has a value of 1010 B.t.u. per cubic foot at the above temperature and pressure.

House Gas in the majority of cities in the United States is required to have a heat value not less than 600 B.t.u. per cu. ft.

Producer Gas may vary from 350 to 400 units in the richer form to 125 units as in the "suction" gas producer, and to as low as 90 units per cubic foot in the gases from the blast furnace, which may be looked upon as a special type of gas producer.

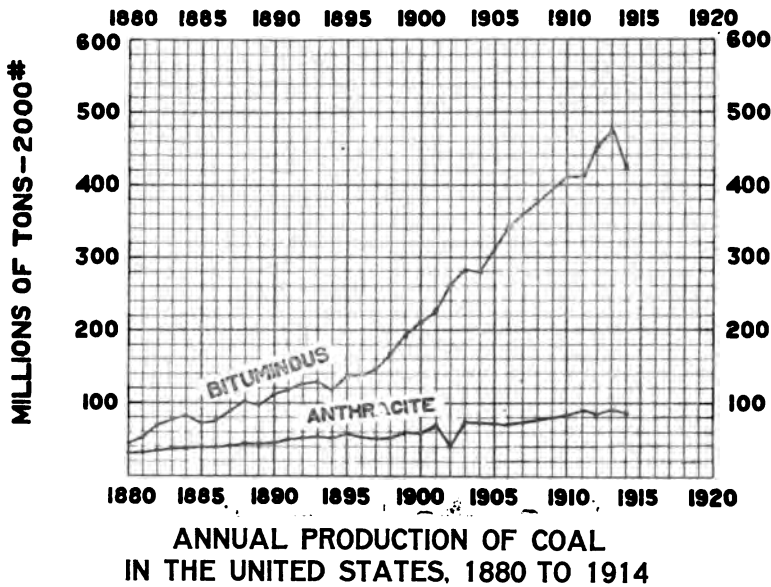

COAL

Introduction.—Of all the fuel supplies available, coal constitutes by far the largest part. Our chief consideration, therefore, will be given to that topic. The annual output of coal in the United States for the year 1914 was 422,329,000 tons. A chart of the production by years is of interest as furnishing an index of industrial activity. A suggestion also is furnished as to the possibility of ultimate exhaustion

of this source of fuel supply, and the necessity of developing the highest possible efficiencies in its use.

Classification.—The classification of coal in common use was outlined by Frazer* in 1877 and was based on his study of the coals of Pennsylvania. A wider knowledge of the character of western and mid-continental deposits calls for the addition of a few subdivisions. In tabular form the following classification based on that of Frazer most nearly approaches everyday usage:

COALS	}	Anthracites,	Volatile matter, below 5%										
		Semi-anthracites,	Vol., 5—10%										
		Semi-bituminous, (Pocahontas)	Vol., 15—22%										
		Bituminous,	<table border="0" style="font-size: 2em; vertical-align: middle;"> <tr> <td style="font-size: 4em; padding-right: 5px;">{</td> <td style="padding-left: 5px;">Eastern, Vol., 25—35%</td> </tr> <tr> <td></td> <td style="padding-left: 5px;">Vein Moist., 2—4%</td> </tr> <tr> <td style="font-size: 4em; padding-right: 5px;">{</td> <td style="padding-left: 5px;">Mid-Continental,</td> </tr> <tr> <td></td> <td style="padding-left: 5px;">Vol., 35—45%</td> </tr> <tr> <td></td> <td style="padding-left: 5px;">Vein Moist., 6—17%</td> </tr> </table>	{	Eastern, Vol., 25—35%		Vein Moist., 2—4%	{	Mid-Continental,		Vol., 35—45%		Vein Moist., 6—17%
		{	Eastern, Vol., 25—35%										
			Vein Moist., 2—4%										
{	Mid-Continental,												
	Vol., 35—45%												
	Vein Moist., 6—17%												
Black Lignites, or sub-Bituminous	<table border="0" style="font-size: 2em; vertical-align: middle;"> <tr> <td style="padding-right: 5px;">Vol., 35—45%</td> </tr> <tr> <td style="padding-left: 5px;">Vein Moist., 17—20%</td> </tr> </table>	Vol., 35—45%	Vein Moist., 17—20%										
Vol., 35—45%													
Vein Moist., 17—20%													
Brown Lignites,	<table border="0" style="font-size: 2em; vertical-align: middle;"> <tr> <td style="padding-right: 5px;">Vol., 25—45%</td> </tr> <tr> <td style="padding-left: 5px;">Vein Moist., 20—25%</td> </tr> </table>	Vol., 25—45%	Vein Moist., 20—25%										
Vol., 25—45%													
Vein Moist., 20—25%													

Numerous systems of classification have been proposed, but none has been received with sufficient unanimity to warrant its general adoption. In the main, they are based on certain ratios which have come to be designated by technical terms as follows:—

Fuel Ratio.—A term originally proposed by Frazer is represented by the fixed carbon divided by the volatile matter: $\frac{\text{Fixed C.}}{\text{Vol. M.}}$ Since

this ratio is highest in the anthracites and semi-anthracites, and lowest in the lignites, it serves in a general way as an indication of the type of coal as well as its behavior under conditions of combustion.

Carbon-Hydrogen Ratio.—This term was proposed by Campbell* and represents the percentage of total carbon, divided by the percentage of total hydrogen, $\frac{\text{T. C.}}{\text{H.}}$ These factors are obtained by ultimate

*Trans. Am. Inst. Min. Eng. 6, p. 430. (1877-8.)

**U. S. Geo. Survey Professional Paper No. 48, Pt. I, p. 168.

analysis and are not usually available. Unfortunately also the hydrogen factor used by Campbell was the total hydrogen of the coal and also of the free moisture which may have happened to be present at the time of analysis. As this constituent is variable and does not govern either the geological or chemical characteristics of the coal it should not be a contributing element in the carbon-hydrogen ratio.

The *Carbon Ratio** represents the volatile carbon, (that is, the carbon joined with hydrogen or other elements to admit of its assuming a volatile form) divided by the total carbon content of the coal and this multiplied by 100 gives directly the percent the volatile carbon is of the total carbon. The advantage of this ratio is the fact that it remains the same whether the moisture and ash are present or absent, thus eliminating some of the most serious variables inherent in many of the proposed schemes of classification.**

ANALYSIS OF COAL

Methods.—Coal may be subjected to either the ultimate or proximate method of analysis. In the former, beside the moisture, ash, and sulphur factors, a determination is made of the constituent elements comprising the organic substance of the coal; namely, carbon, hydrogen, nitrogen, and oxygen.

In the proximate method, besides the moisture, ash, and sulphur, there are determined, instead of the elemental substances of the organic part, only volatile matter and fixed carbon. The ultimate analysis furnishes data from which the heat value of the coal can be calculated. The proximate analysis gives the necessary data for judging of the kind and general character of the coal. It is the proximate method only which will be here considered, the main object being to discuss the significance of the various factors, methods of calculation, etc. The

*Parr, S. W., The classification of coals: J. A. C. S., Vol. 28, 1906, p. 1425.

**A brief bibliography of discussions upon coal classification is given as follows:—

Johnson, W. R., Report to United States Government on "American Coals," 1844.

Ure's Dictionary, 1845.

Frazer, Persifer, Jr., Trans. Min. Eng., Vol. 6, 1878, p. 430.

Watt's Dictionary of Chemistry, Vol. 1, p. 1032.

Rogers, H. D., Report to English Government, Vol. 2, Pt. 2, p. 983.

U. S. G. S. Professional Paper No. 48.

Parr, S. W., Jour. Am. Chem. Soc., Vol. 28, p. 1425.

Campbell, M. R., A. I. M. E., Vol. 36, p. 324.

Grout, F. F., Economic Geology, 1907, p. 226.

White, David, U. S. G. S. Bulletin No. 382.

analytical methods are taken up elsewhere under the directions for the laboratory processes.

SAMPLING

Introduction.—Samples may be taken by different methods and for a variety of purposes. Three kinds are generally recognized:

- 1—Hand Samples
- 2—Face Samples
- 3—Commercial Samples

Hand Samples.—As the name implies, hand samples are taken in small amounts and the entire sample is submitted for inspection and analysis. In the nature of the case such samples are selected and are not representative of the mass from which they come. Their analysis may be of interest to the person collecting them but the results are utterly without commercial value or significance.

Face Samples.—This term is applied to samples taken at the working face of a coal seam. They are essential for purposes of scientific study and serve as a basis for determining the changes that occur in the process of mining, transportation and storage. The taking of such samples is not different in principle from the taking of commercial samples. The chief essential is a kit of the knock-down type, not too heavy for packing and not too tedious in setting up and operating. Specific details are not given here.*

Commercial Samples.—The majority of samples are taken in connection with industrial operations, in the process of coal inspection, control of contracts, determination of efficiencies, etc., and involves the sampling of wagon loads, car lots, barge shipments and masses in storage. The general principles under any of these conditions are the same. The important features to be observed are given special emphasis as follows:—

COMMERCIAL SAMPLING**

Necessity of Care.—Without question, the critical point in the entire range of coal inspection and analysis is in the sampling. If the sample taken is truly representative of the entire lot, the results, if accurate in themselves, furnish correct information as to the larger mass of which the sample is a part. If, on the other hand, the sample is in error, the results of the analysis though correct in themselves will be in error so far as they relate to the mass under consideration. Throughout the process of sampling two points must be observed with scrupulous care:

*See Bulletin No. 29, Ill. State Geol. Surv., p. 17.

**Adapted from Ill. State Geol. Surv. Bulletin No. 29. Purchase and Sale of Illinois Coal on Specification. By S. W. Parr. (1914.)

First—The sample taken must be representative of the whole, that is, the distribution of the various substances which go to make up the original mass must be maintained without any change in the relative amount of the various constituents.

Second—The moisture content, which changes readily, must be under exact control so that at any stage the ratio of moisture present to the original moisture of the mass may be definitely known.

Material to Be Taken:—As stated above, the first essential in a sample is that it shall truly represent the mass of which it is a part. To secure this result a few fundamental conditions must be observed, as follows:

The gross sample must be representative of the various kinds of material present. That is to say, a mass of coal consists of fine stuff, lump, bone, slate, pyrites, and other constituents. As a rule the “fines” differ in composition from the lump, hence the sample must have these two sorts of material in their proper proportion. The same is even more true of slate or pyrites, of which the composition differs so widely from that of the major part of the mass. An undue amount of such material would cause a serious disturbance in the accuracy of the sample.

Amount:—In procuring a representative sample a large element of safety resides in the quantity taken. In general, the larger the amount, the more representative it will be. However, conditions differ. It is easier, for example, to procure an even sample from the face of a working vein or from a carload of screenings than from a carload or other mass of lump or run-of-mine coal. In the latter case larger amounts should be taken than in the former.

The limits of practicability for the proper handling of the sample must however be considered. In general, the gross sample should weigh approximately from 200 to 600 pounds. Doubtless 200 pounds of screenings, taken with fairly good distribution throughout the unloading of a 40- or 50-ton car, will yield a very true sample. The difficulties increase greatly with the increase of the size of the particles, as in the case of lump or mine-run coal. If mechanical appliances for grinding are available, the larger amount should be taken, but a smaller sample well crushed down before quartering is better than a greater mass quartered down while the particles are still in larger pieces.

Ratio of Size to Mass:—Assuming that the sample as taken is made up of the various kinds of material in proper proportion, the next important item is to maintain these variables in their ratios throughout the process of reducing the gross amount to a small working or laboratory sample. To insure this result, there must be maintained a certain ratio of size of the particles to size or weight of the mass. This, as a

rule, is based on a formula which provides that the weight of the largest piece of impurity shall have a ratio to the weight of the mass of about 2: 10,000. For example, a mass weighing 10,000 grams, or about 22 pounds, should contain no particles weighing more than 2 grams. This would mean that the largest particle, as for example, a piece of iron pyrites, must not be over $\frac{1}{4}$ inch in its greatest diameter.

The final ratio of sizes, however, should be determined by the methods available for grinding. With mechanical appliances for obtaining the smaller sizes, a table of ratios with greater safety limits can be adopted than is perhaps practicable where the crushing is done by hand. If a power crusher is available, the entire sample should be passed through the mill and reduced to a size which will pass a $\frac{1}{4}$ -inch screen. If the crushing must be done by hand, the first reduction in size of the particles should be such that the entire mass will pass through a 1-inch screen. When by quartering, the sample is reduced to 100 pounds, the size of the particles should be further reduced to a size that will pass a $\frac{1}{2}$ -inch screen, and with a 50-pound sample in hand the crushing should be carried to $\frac{1}{4}$ -inch mesh. The subdivisions with their respective sizes are shown in tabular form as follows:

TABLE VIII
SIZE OF MESH FOR DIFFERENT SUBDIVISIONS OF SAMPLE

Weight of subdivisions of sample (pounds)	Size of mesh to which each subdivision should be broken (inches)
500	1
250	$\frac{3}{4}$
125	$\frac{1}{2}$
60	$\frac{3}{4}$
30	$\frac{1}{8}$

Illinois coals are easily crushed in mills which are available at little expense. Hence it is entirely reasonable to require that gross samples, when reduced in mass to 50 or 75 pounds, shall be passed through a mill set for grinding to approximately $\frac{1}{8}$ inch. For this work, a mill which is not of the jaw-crusher or roller type is preferred, since these types produce too large a percentage of fine material, and the harder pieces of slate, especially those of flaky or plate-like structure, are liable to pass in pieces having inadmissably large dimensions in two directions, even though the adjustment used would seem to be fine enough to prevent the passage of such material. A grinder of the coffee-mill type or one with projecting teeth on the grinding surfaces will be found to produce a more uniform size and the minimum amount of dust. The grinding surfaces of such a machine are shown in figure 6, and the same type of mill is shown set up in figure 7.



Figure 6—GRINDING SURFACES OF COAL CRUSHER

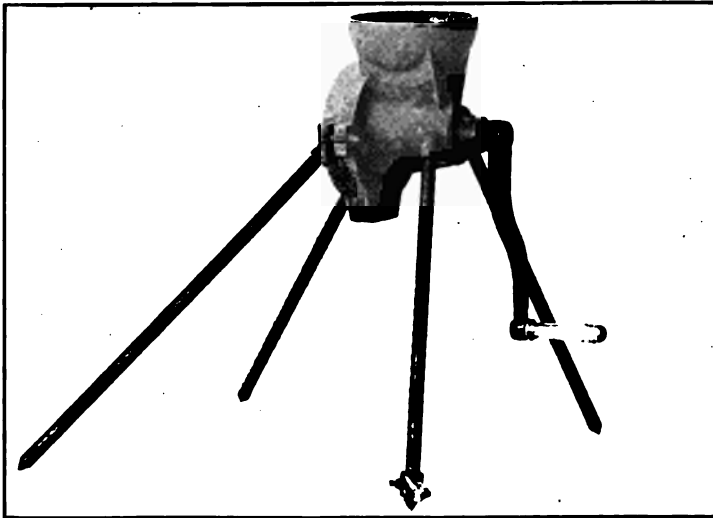

Figure 7—COAL GRINDER OF THE COFFEE-MILL TYPE
Weight about 16 pounds. Readily knocked down for packing. Especially Designed
for use in taking Face Samples.

Mixing and Subdividing:—As a further precaution in maintaining a correct distribution of the various constituents, emphasis is placed upon

the necessity of thorough mixing, followed by even selection of the remaining sub-divisions. It is true that fine grinding contributes materially to this end but further care is necessary. It is entirely practicable to mix a 50-pound sample, ground as above described, by rolling in an oilcloth about five feet square. This is accomplished by taking one corner of the cloth and carrying it over the pile towards the diagonally opposite corner so as to cause the mass to roll over upon itself, then reversing the motion and repeating the process with the other two corners. Fifteen or twenty such alterations, depending somewhat upon the size of the sample, should be sufficient to effect an even mixture. Where available, however, especially in commercial sampling, a mixer is to be preferred. Such a device is most conveniently made in the form of a drum having cone-shaped ends capable of being closed air-tight, and mounted so as to revolve endwise.

The subdividing of the larger sample, to reduce it to a convenient size for transmission to the laboratory, requires special consideration as having an important bearing on the maintenance of the correct ratio of constituents. This may be best shown by the data given in Table IX.

TABLE IX
ASH VARIATIONS IN DIFFERENT SIZES OBTAINED FROM DUPLICATE 3-POUND SAMPLES

Series	Mesh	Duplicate halves	Per cent of each size	CO ₂ in "dry coal"	Ash corrected for CO ₂ in "dry coal"	<i>a</i> and <i>b</i> composited by calculation
1 ₁	On 20	<i>a</i>	41.7	.40	14.11	<i>a</i>16.32 <i>b</i>15.86 Average.....16.09
		<i>b</i>	48.4	.37	14.00	
1 ₂	Through 20 On 60	<i>a</i>	41.7	.85	15.55	
		<i>b</i>	37.9	1.00	15.42	
1 ₃	Through 60	<i>a</i>	16.6	1.31	23.89	
		<i>b</i>	13.7	1.38	23.65	
2 ₁	On 20	<i>a</i>	29.1	.53	15.91	
		<i>b</i>	25.0	.46	15.68	
2 ₂	Through 20 On 60	<i>a</i>	48.4	.94	16.23	
		<i>b</i>	51.9	.98	16.06	
2 ₃	Through 60	<i>a</i>	22.5	1.32	24.09	
		<i>b</i>	23.1	1.28	23.98	

Note in this table that series 1 and 2 are 3-pound samples taken by subdividing in the same manner the same gross sample of about 30 pounds. Each sample was ground to 8-mesh and sized. It will be seen that in series 1, duplicates *a* and *b* had 16.6 and 13.7 per cent of the 60-mesh size, whereas in series 2 the duplicates *a* and *b* had 22.5 and 23.1 per cent respectively. Note further the great increase in ash in the fine size as compared with the ash in the coarse material. For example, series 1 having an average of 14 per cent of ash in the coarse size has an average of 23.75 per cent in the fine portion. A similar increase in ash is seen in the corresponding sizes in series 2. The ultimate ash average for series 1 is 16.09 per cent and for series 2 it is 17.85 per cent.

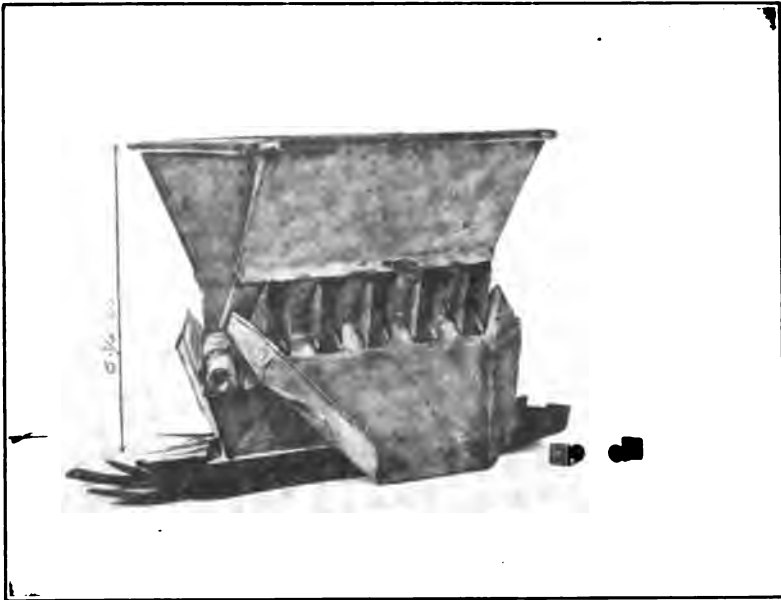

Figure 8—RIFFLE

These values vary consistently with the variation in the percentages of fine material in the respective series. On the other hand, the duplicate halves *a* and *b* throughout, because of their uniformity resulting from the sizing process, show results in the several pairs which check very closely.

The values as presented in the table, therefore, show clearly that in the process of subdividing the gross sample and in the further reduction of the sample as received at the laboratory, great care must be exer-

cised to see that no part of the manipulation is of such a nature as will promote segregation of the constituents.

A riffle constructed according to the pattern shown in figure 8 may be used to advantage after the sample has been reduced by quartering to about 30 pounds. At this stage the sample is ground to 1/8-inch size, hence the riffle openings may be 1/2-inch in width. With this variation in the openings the riffle as shown in figure 8 is substantially the one described in the Bulletin of the Ohio Geological Survey, No. 9, p. 313, 1908.

Moisture Control.—The second essential in taking and preparing a sample relates to the free moisture present, and requires that the changes in moisture content “must be under exact control so that at any stage the ratio of the moisture present to the original moisture of the mass may be definitely known.”

Loss of Moisture.—In coals of this region especially, where the moisture in the coal as it comes from the mine averages from 10 to 15 per cent the tendency toward moisture changes is very marked. For example, the process of crushing down the larger sizes affords an opportunity for the escape of moisture. Again, if the coal is spread out on the floor of a hot boiler room or left exposed to currents of air for any length of time there will be a serious change in the moisture factor. Another practice sometimes followed is that of assembling the various increments of the gross sample in a sack or other receptacle permitting a relatively free transmission of air. Samples kept in this manner for any length of time or shipped in such containers will have a moisture content quite different from the original.

Precautionary Measures.—The methods employed, therefore, in collecting and reducing a gross sample must have special reference to this tendency on the part of the free moisture to escape. The work should be done rapidly in a room at or below the normal temperature and, so far as possible, with the use of closed apparatus which admits of the least possible exchange of the contained air. Precautionary measures of this sort should be made at the very outset. The gross sample, which is made up of small increments collected usually over a considerable length of time, should be enclosed in a tight box or clean garbage can having a tightly fitting cover which can be closed and locked against the possibility of change until the time for grinding and reducing.

Sampling a Car Load.—A car of coal may be sampled to the best advantage in the process of unloading. An occasional half shovelful should be thrown into a proper receptacle so that by the time the car is unloaded approximately 200 pounds, evenly distributed throughout the load will have been taken. This will mean about one-half shovelful for every ten full scoops. They are best taken in the process of shoveling from the bottom of the car, since the top coal rolls down and mixes fairly

evenly with the bottom. It should be kept in mind that in taking a sample there must be obtained the different sizes of coal, fine and coarse in their proper proportions from the entire cross-section of the mass, and also an even distribution of the sample lengthwise of the car. Even greater care must be taken to guard against loss of moisture in the process of collecting and in reducing the gross sample for the reason that as a rule the relative humidity outside of the mine is lower and the tendency of the moisture to leave the coal is correspondingly increased.

Sampling the Car Without Unloading:—It has been shown in Table IX, that the finer particles of a coal mass are higher in ash and hence have a greater specific gravity. They are therefore more likely to separate by gravity from the coarser material. On this account, if a car is to be sampled without unloading, it is necessary to dig well toward the bottom in order to obtain a representative sample. Three trenches should be dug crosswise of the load, one near each end and one near the middle of the car. These trenches should go down nearly to the bottom of the mass and each size be taken as nearly as possible in its proper proportion. Lump and run-of-mine lots are much more difficult to sample than screenings, but it should be noted that screenings may vary greatly, for not infrequently a car is partially loaded from one bin and finished from another which may be of a different size and composition. After obtaining the gross sample, the methods to be followed are the same as those already given.

Composite Samples:—It is often desirable to composite a number of samples. In this way a single sample may be made to represent a much larger quantity of coal and thus cut down the time and expense involved in procuring the analytical data. In this procedure, however, it must be remembered that even greater care should be exercised in taking the several component samples. The amount of each sample entering into the composite must be in proportion to the mass which it represents, and finally a thorough and positive mixing of the composited mass must be effected before riffing down the same to the usual 5-pound quantity.

It is convenient to determine the amount of each sample to be taken by employing an aliquot system of weights. For illustration: Suppose we adopt 1 gram to the 100 pounds as the unit which shall enter into the composite. Then a 100,000-pound car of coal should be represented by 1,000 grams. In compositing, therefore, the entire content of each car will not be taken, but instead an aliquot proportion which will give to each car lot its due amount. It is preferable to use such a factor as shall utilize the major part of the several 5-pound samples. In this way the gross composite from 10 cars would aggregate 20 or 30 pounds in weight. It should be put into the mixer and revolved until a thoroughly

homogeneous mass is obtained and then riffled down to a 5-pound sample as already described. For this procedure it is obvious that the necessary data should accompany the various samples. A ticket inserted in the can before sealing should give the data needed.

Mechanical Sampling:—Numerous attempts have been made to de-

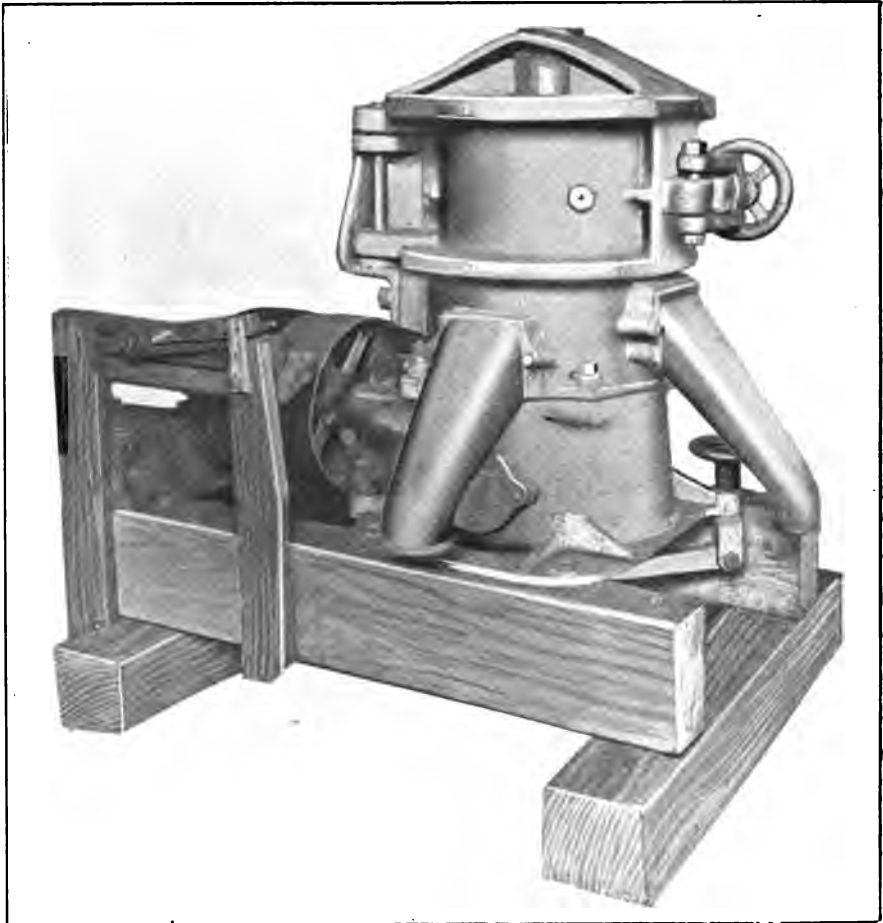

Fig. 9. Sample Grinder. Sturtevant Mill Company, Boston, Mass.

vis a mechanical method for taking samples. While it is possible, by such means to eliminate the personal equation, it is difficult to avoid segregation or an uneven distribution of coarse and fine material. In the sample grinder illustrated in Fig. 9, there is an evident advantage that

with a power grinder larger samples may be handled, thus dividing rather than multiplying the errors. Fig. 10 shows the method of opening up and cleaning the grinder at the end of the operation. Both the central grinding cone and the wing stirrer underneath may be lifted out for cleaning the entire grinding and distributing chamber. The sampling feature is so arranged that an aliquot part, approximately 10 per

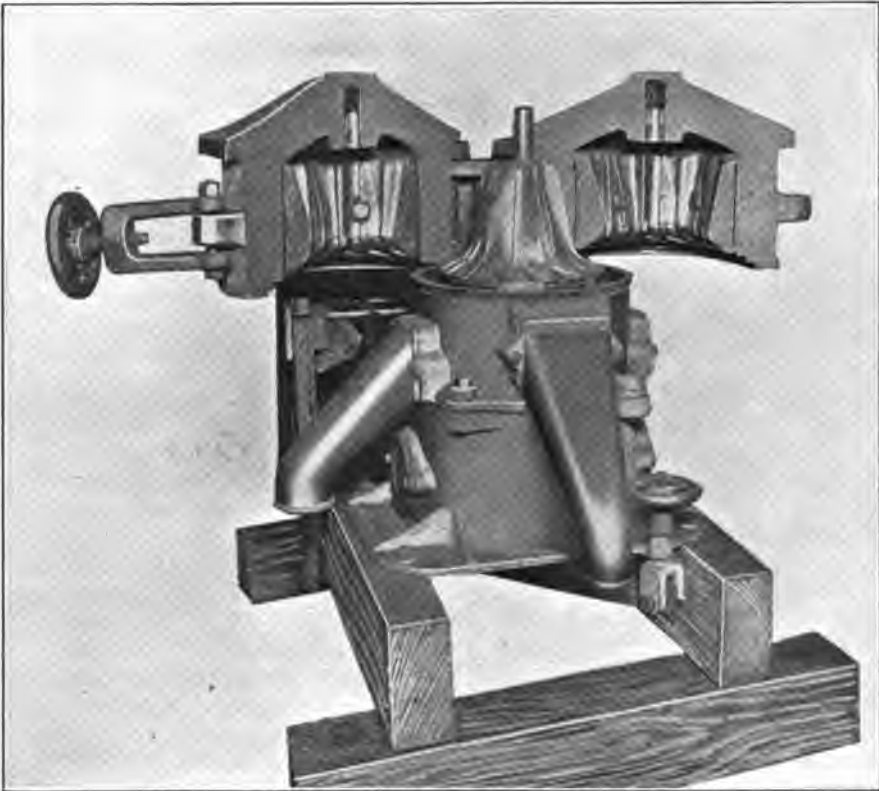

Fig. 10. Grinder Opened for Cleaning

cent, is delivered into the small receptacle in the process of grinding the original mass. In use of such a sample grinder, the facility with which the material may be passed through makes it possible to take much larger initial samples. For example, if occasional shovelfuls are taken, well distributed throughout the unloading of a car in such an amount as to yield say 40 pounds in the aliquot portion, then it is known that ap-

proximately a 400-pound gross sample has been passed through the grinder.

Accuracy of the Device:—Doubtless the best method for determining the accuracy of the sample delivered by the apparatus is to compare the ash values, water free basis, as obtained from the small sample with the ash value from the main portion, sampled by carefully quartering down by hand in the usual manner. A number of tests of this sort are shown in the Table No. X.

TABLE X

ACCURACY OF SAMPLE GRINDER

Comparison of Ash Values. Dry Basis

Samples A and B obtained from Main Portion by Quartering and Riffing.

Laboratory Number	Coal	Ash in small sample as delivered by grinder	A Ash in main portion sampled by quartering and riffing	B Ash in main portion. Duplicate of A:—Opposite quarter
8661	Vermilion Co. Screenings	15.53	15.22	15.72
8664	Vermilion Co. Screenings	14.52	14.52	14.65
8667	Vermilion Co. Screenings	19.19	19.88	19.72
8670	Vermilion Co. Screenings	17.43	17.78	17.58

Another test has been applied as follows: The samples as obtained in the process of grinding 10 gross samples were delivered into a common receptacle in their proper proportions for compositing. Without further mixing, the mass of approximately 40 pounds was poured into the grinder. The accuracy of the small sample thus obtained was determined as before, by comparison of ash values. The main portion was sampled again by pouring through the mill a second time for a duplicate aliquot delivery. The results are shown in Table No. XI. In both of these tables the agreement between the sample delivered by the mill and the sample obtained from the main portion is very satisfactory, especially when we consider the variations inherent in the processes of analysis for high ash coals.

TABLE XI

ACCURACY OF SAMPLE GRINDER

By Comparison of Ash Values. Dry Basis

DUPLICATE SAMPLE OBTAINED BY SECOND PASSAGE OF MAIN PORTION THROUGH MILL

Laboratory Number	Coal (Screenings)	A First aliquot of 10 per cent as delivered	B Second aliquot of main portion
8668	Moultrie County	19.61	19.60
8934	" "	20.32	20.38
8961	" "	20.94	21.13
8973	" "	19.21	19.82
9011	" "	19.21	19.17
9013	" "	19.62	19.41
9025	Montgomery "	13.69	13.44
9143	Moultrie "	19.64	19.67
9147	" "	19.83	20.03
9162	" "	20.14	20.26
9160	Montgomery "	14.17	13.89
9180	Moultrie "	19.32	18.94
9185	Montgomery "	13.30	13.48
91.95	Moultrie "	19.72	19.90
91.97	" "	18.61	19.18
9240	Montgomery "	13.20	12.95
9242	Moultrie "	19.82	19.89
9244	" "	18.93	18.96
9268	Montgomery "	13.48	13.43

MOISTURE

Moisture Conditions and Nomenclature.—The topic of moisture control has already been discussed, emphasis having been laid upon the fact that at any stage of the processes the exact ratio of the moisture present to the moisture of the original mass must be definitely known. This implies that moisture changes do occur. Indeed three moisture conditions exist and, since under each condition all of the accompanying factors are modified to meet the specific change in moisture, a special designation is applied to the coal for each one of these conditions.

Coal with all of the normal moisture present is designated as "wet" coal or coal "as received." It relates to the moisture at the time of taking the sample. All of the detail of the processes for collecting and re-

ducing the gross sample up to and including the item of sealing and shipping the 5-pound sample involve the preservation of this initial moisture without loss.

The second moisture status is that wherein the "wet" or "as-received" coal has been dried to a point of substantial equilibrium with the moisture of the air, so that in an atmosphere of average humidity it would take on or lose additional moisture very slowly or not at all. In this condition the coal sample is said to be "air dry." This is the condition to which the chemist must bring the sample in order that the processes of finer grinding and weighing may be carried on without change in the moisture factor. Obviously the amount of moisture lost in passing from the "wet" or "as-received" condition to the "air-dry" condition must be carefully measured. The factor thus determined is designated as the "loss on air drying." By use of it all of the values obtained from analysis of the coal in the "air-dry" state may be calculated to the "wet" or "as-received" condition.

The third condition recognized is that of "dry" coal. This is sometimes designated as the "oven-dry" or "moisture-free" state. All of the values found for the coal in the "air-dry" condition may be transferred by calculation and made to apply to the coal as "oven-dry." The necessary factor in this case is the loss of moisture obtained from drying the "air-dry" sample at or slightly above steam temperature, as 220° F. for one hour. It is not intended here to give directions for carrying out these processes. The terms employed, however, are of so frequent occurrence, and in many cases enter so vitally into a correct understanding of the methods upon which certain values are based in the making of estimates and arriving at fuel settlements that at least a brief reference seems desirable.

Carelessness in the use of these terms leads to much confusion. The chemist and the engineer are not always in agreement as to their meaning. The results as obtained by chemical analysis upon the air dry sample are of little use to the engineer, whose basis of reference is to the "as-received" or to the "dry" basis. For the purpose of the engineer it is necessary, therefore, to calculate the results which are obtained on the air dry sample back to the "wet" coal and also to the "dry" basis.

Calculations:—To calculate the percentage values obtained on "air-dry" coal to the "dry-coal" basis, divide each constituent by $(1-w)$ in which w is the moisture present in the "air-dry" sample. The moisture factor for the "dry" coal is omitted of course, and the sum of the resulting constituents should total 100 per cent.

To calculate from the "air-dry" values to the "wet," or "as-received," condition multiply each percentage for the "air-dry" state by $(1-l)$ in which l is the loss on air drying. The moisture factor thus

derived plus the loss on air drying equals the total moisture in the "wet" coal. This and the other factors calculated as described should equal 100 per cent.

INTERPRETATION AND USE OF ANALYTICAL RESULTS

General Plan:—The general purpose involved in making a chemical analysis of coal is to furnish a basis for estimating values. In its simplest form it consists in separating the inorganic or non combustible from the organic or heat-producing material. The following outline may serve as an illustration :

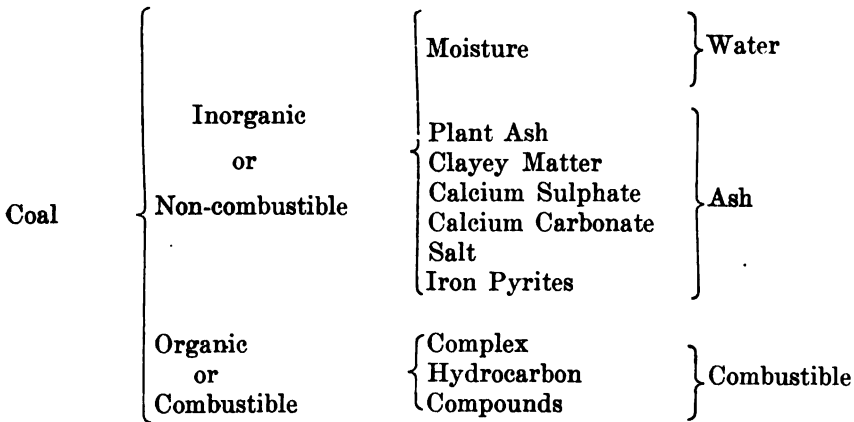

It will be seen from the diagram that the constituents of fundamental importance are in reality only three in number: Water, ash, and combustible matter. The meaning and use of these values especially in some sort of their modified or corrected forms may be made of great service in connection with the purchase and sale of coal on specification.

The Interpretation of Moisture Values:—"The significance of the factor for moisture is important. In coals with high moisture in the vein, a large shrinkage in weight occurs in the process of shipment. In the majority of cases, settlement is made upon the basis of the mine weights. This loss of moisture, therefore, falls ultimately upon the consumer."

There is a certain agreement also between combined oxygen or the water of constitution and the content of free moisture in the vein sample; the higher the moisture, the more combined oxygen and the smaller the percentage of combustible in the volatile matter. For this reason there are more heat units per pound of combustible (ash and moisture free) in Pocahontas coal, with 2 per cent of vein moisture, than per pound of combustible (ash and moisture free) in Illinois coal, with 12

per cent of moisture in the vein sample. The vein moisture, therefore, becomes to a very considerable extent an index of the type or composition of the organic part of the coal. These variations in property will be discussed somewhat further under the topic of Unit Coal.

Ash.—Ash is the inorganic constituent of the coal aside from water. As commonly defined, it is the residue left after burning and is made up of complex substances such as sand, shale or kaolin, gypsum, calcium carbonate, iron pyrites, etc. But, from the list it is evident that there is much opportunity for loss of constituents such as combined water and CO_2 in the process of burning, which, if not corrected for, come to be reckoned as part of the combustible matter. There have come into use, therefore, in connection with the ash determination two terms expressive of this material; namely, "ash as weighed" or simply "ash," and "corrected ash."

The use of a corrected ash factor is primarily of interest in the accurate determination of the amount of active or organic matter present. Thus, unless the line of demarcation between the organic and inorganic substance is properly and precisely drawn, we do not have a correct unit for the true combustible material. This point will be better understood from the discussion of the next topic, Unit Coal.

Unit Coal.—In fuel literature three terms have come into use:

1. Combustible.
2. Ash and Water Free Substance.
3. Pure Coal.

These terms are synonymous and are intended to represent the active or actual coal substance. The heat value, for example, when referred to the combustible matter, is found by dividing the heat value as obtained on the wet coal by 1—(sum of moisture and ash as weighed). From the discussion in the previous paragraph it is evident that there will be a very considerable error unless we make use of a corrected ash, hence there has been suggested* another term, that of Unit Coal, which is intended to stand for the pure or actual coal substance as derived from taking into consideration the corrected ash. In other words the attempt is made to differentiate between the non-coal substance and the coal itself. The latter is a fairly constant material in its heat producing property and general make-up of its chemical compounds. The non-coal substance on the contrary is made up of a number of ingredients, more or less adventitious, and varying both in actual amount present and also in composition as they pass through the processes of analytical determination. For example the iron pyrites which is a large factor in the non-coal material is weighed out with the coal in the form of FeS_2 . After

*Illinois Eng. Exp. Sta. Bulletin No. 37.

burning to ash it becomes Fe_2O_3 and the application of a correction factor to the ash as weighed is necessary if we wish to revert to the original condition of the ash. Similarly, the shale or clayey constituents have in chemical combination, a certain amount of water which is not driven off by drying at steam temperature, but is delivered at a red heat in the process of ashing. Here again, if we wish to obtain a factor for the true ash or non-coal substance we must apply another correction to account for this loss of combined water. An expression, therefore, for the non-coal substance has been adopted as follows:

Non-coal = Moisture + Ash-as-weighed + $5/8$ S + .08 (Ash-as-weighed — $10/8$ S).

The factors in this expression are derived as follows: In the ash as weighed the FeS_2 of the original coal has burned to Fe_2O_3 . In this combination the atomic ratio of the oxygen to the total sulphur which it replaces in the original FeS_2 (that is, 2 (FeS_2)) is 48 : 128 or 3 : 8. That is to say—oxygen has combined with the iron to the extent of $3/8$ of the original sulphur. Hence the ash as weighed may be corrected or brought to its original form so far as the FeS_2 is concerned by adding $5/8$ of the weight of the sulphur present in the coal.

Again the ratio of iron to sulphur in iron pyrites (FeS_2) is 56 : 64; that is, the amount of iron present is $7/8$ of the weight of the sulphur. The combined iron and oxygen, therefore, weighed as Fe_2O_3 , are equivalent to $7/8 + 3/8$ or $10/8$ of the sulphur present. Hence the expression (Ash-as-weighed — $10/8$ S) represents the ash with the pyritic iron or the resulting oxide Fe_2O_3 removed. Therefore, since the original FeS_2 from which it comes has no combined water, it is subtracted before applying the correction constant of 0.08. This 8 per cent is a constant and represents the water of hydration for the clayey constituents which we wish to restore to the ash as in its original form.

The above formula for “non-coal” becomes therefore the expression for the true coal or “Unit Coal” in percentage values as follows:

Unit Coal = 100 — (Water + Ash-as-weighed + $5/8$ S + .08 (Ash-as-weighed — $10/8$ S)).

By clearing of fractions and bringing to its simplest form, this expression becomes:

Unit Coal = 100 — (W + 1.08 A + $21/40$ S) in which W is the percentage of water, A is the percentage of ash-as-weighed, and S is the sulphur content. In this expression the factor $21/40$ S can not be further simplified by making it $1/2$ S, for the reason that our correction for sulphur is already too small by that part of the organic sulphur not covered by the addition to the ash value of $3/8$ of the total sulphur indicated in the original formula. On the contrary, we shall be approaching nearer the truth by increasing slightly the sulphur correction, which

may be done with convenience in calculating, by making this factor read $22/40 S$ or $1/2 S + 1/20 S$.

Sulphur:—This constituent of the ash is made a matter of separate determination. The question might be raised as to whether the sulphur should not be grouped with the true coal substance since it contributes somewhat to the heat values in the burning process. But it is distinctly a mineral substance, varies widely in amount and affects the properties of the coal far more specifically through the ash than in its contribution to the heat volume, which is relatively small in amount. Moreover, by segregating it from the heat producing constituents and taking away the heat also which may be credited to it a far more consistent value remains as the true heat to be credited to the Unit Coal substance. This procedure will be found to have very great practical value as well as being of great advantage in the comparative study of coals for classification and similar purposes. Since the sulphur of coal occurs chiefly as iron pyrites, FeS_2 , it is generally believed that a high sulphur factor represents a high iron factor and, consequently, a tendency for the coal to clinker in burning. This does not necessarily always follow, but it is true in the main. The average content of sulphur in Illinois coals is from 3 to 4 per cent, with an occasional output as high as six or even seven per cent. In the southern and southeastern field, however, as in Franklin, Williamson, Saline and Jackson Counties, the sulphur content will average from 1 to 2 per cent.

Volatile Matter and Fixed Carbon:—The organic matter of coal when heated above 500 or 600 degrees decomposes giving off combustible gases and, if the temperature is continued to a bright red heat, there remains, in addition to the ash, the fixed carbon or coking constituent of the coal. The volatile matter is of significance largely by reason of the fact that this part of the combustible substance has a tendency to escape into the flue spaces before complete combustion has been effected. With mechanical stokers and modern equipment, this would not occur and, consequently, the matter of high or low volatile matter is of less significance than formerly. In domestic appliances, however, this is not the case, and larger losses occur in the process of combustion. For such uses, therefore, higher efficiency will be obtained from coals with less volatile matter and a higher percentage of fixed carbon.

Fixed Carbon:—The fixed carbon represents the amount of combustible matter which remains behind for complete combustion in the fire box. Its value, therefore, depends upon the form of appliance in which the coal is burned. The fixed carbon plus the ash represents approximately the coke content that might be expected from the original coal.

CALORIMETRIC MEASUREMENTS

Definitions:—Heat values are expressed in two ways,—as Calories and as British thermal units. Only the large Calorie is made use of in fuel reference and it represents the amount of heat necessary to raise 1 kilo of water through 1°C. The full expression is, therefore, Calories per kilo or kilo-Calories.

The British thermal unit represents the amount of heat necessary to raise 1 pound of water through 1°F. The full expression, therefore, would be B.t.u. per pound.

Since the Centigrade degree is 9/5 or 1.8 times as great as the Fahrenheit degree, and the kilo is 2.2046 times the pound, it follows that one Calorie would be the equivalent in Fahrenheit degrees of 1.8×2.2046 or 3.968 B.t.u. However, the comparison between units as thus developed is not a comparison between values as made use of in the case of fuels for the reason that the arbitrary amount of coal to which reference is made in both cases is an amount of coal equal to the unit of water developed, that is a kilo of coal to a kilo of water, a pound of coal to the pound of water. For this reason, therefore, the rise in temperature in each case is the same. That is, a pound of coal will raise the temperature of a pound of water through as many degrees as a kilo of coal will raise a kilo of water, or a ton of coal a ton of water, etc. The difference in heat values as expressed by these two methods, therefore, is simply the difference in the thermometric readings. A reading taken by the Fahrenheit scale will be 9/5 or 1.8 times as great as the reading taken by the Centigrade scale. Therefore, to change fuel values expressed in Calories per kilo to B.t.u. per pound, multiply by 1.8.

Heat Values by Calculation:—Heat values may be determined from the ultimate analysis by Dulong's formula, which assumes that the heat comes from the combustion of carbon, hydrogen, and sulphur. The usual values for these constituents are

Carbon = 8,080 Cal. or 14,544 B. t. u.

Hydrogen = 34,500 Cal. or 62,100 B. t. u.

Sulphur = 2,500 Cal. or 4,500 B. t. u.

Expressed in the latter set of values, therefore, Dulong's formula becomes

$$14,544 C + 62,100 \left(H - \frac{O}{8} \right) + 4,500 S = \text{B.t.u.}$$

In this formula the expression $\left(H - \frac{O}{8} \right)$ represents what is termed the available hydrogen; that is, the amount left after subtracting the equivalent hydrogen needed to unite with the oxygen present to form water, 2:16 or 1/8 O.

Presumably such calculated values would be in close agreement with indicated values by means of a carefully operated instrument. This is true for certain regions, but not for others. The divergence is more pronounced in coals of this region than in the coals of the Eastern United States. "In view of the possible presence of calcium carbonate and the consequent error in the ash determination for many Illinois coals, it is evident that a direct variable in such cases enters into the value for oxygen and consequently for the available hydrogen, which would thereby result in a discrepancy as between the indicated and the calculated calorific values. Moreover, a high percentage of oxygen in combination evidently may be responsible for variations of quite a different character, as, for example, a different distribution of such oxygen in a manner not altogether correctly covered by the expression $\frac{O}{8}$, or in the ultimate form of water. There seems to be, therefore, numerous reasons why a calculated calorific value by use of Dulong's formula is of little value for coals of this type."*

Derivation of Heat Values for Unit Coal:—It is obvious that if the heat value of the unit coal is constant within narrow limits for a given mine or region we may if such unit values are known, reverse the calculation, making use of any assigned values for moisture, ash and sulphur, and so determine by calculation the heat value of commercial product for that particular mine or region for which the unit coal value is a constant. We shall need to discuss in the first place, therefore, the method of calculating unit coal values.

From our previous discussion of the formula which has been developed to represent the percentage of unit coal, it is readily seen that the expression for deriving the heat value for that substance would be as follows: Using "W" for water, "A" for Ash, and "S" for sulphur. For coals with values given on the "as-received" or "wet" basis:

$$\text{B.t.u. of Unit Coal} = \frac{\text{Indicated (Wet) B.t.u.} - 5,000 \text{ S.}}{1.00 - (W + 1.08A + 22/40S)}$$

For coals with values given on the "dry" or moisture free basis:

$$\text{B.t.u. of Unit Coal} = \frac{\text{Indicated (dry) B.t.u.} - 5000 \text{ S}}{1.00 - (1.08A + 22/40 \text{ S})}$$

*Parr, S. W., Ill., S. G. S. Yearbook, 1909, p. 236.

Also, Porter and Ovitz, Bureau of Mines, Bulletin No. 1, p. 28-29.

The expression 5000 S has been used as indicating the heat due to the combustion of sulphur, for the reason that the value 4500 S as used in Dulong's formula represents the heat of combustion for pure sulphur, while the heat of combustion of sulphur in the form of pyrites, FeS_2 , combines also the heat of formation of iron oxide, Fe_2O_3 . It is the resultant value, therefore, of the several reactions involved that is desired.

According to the direct tests by Somermeier,* in the combustion of coal with known wights of iron pyrites, the indicated heat per gram of sulphur so combined is 4957 calories. In calculating heat values, the correction introduced for the combinations resulting from calorimeter reactions as compared with open-air combustion is 2042 calories per gram of pyritic sulphur; hence 4957 — 2042 or 2915 calories (5247 B.t.u.) represents the heat due to burning one gram of sulphur in pyritic form instead of 2250 calories (4050 B.t.u.), the amount which would be credited to sulphur in the free condition. A strict application of these values, therefore, would call for a correction of 5247 S, as representing the heat to be subtracted for the sulphur. This, however, would imply that all of the sulphur is in the pyritic form. Since a certain portion of the sulphur is always present in organic or other form of less heat-producing capacity, it is deemed more nearly correct to use an even factor of 5000 as representing the heat to be credited to unit amounts of the total sulphur present.

By computing the heat values as derived by this formula for solid fuels throughout the United States, as published by the United States Geological Survey, the Ohio State Survey, and the Illinois Geological Survey, we have in tabular form, giving the extremes for each general fuel type, the following:

TABLE XIII

CLASSIFICATION OF FUEL TYPES BY HEAT VALUES FOR UNIT COAL OR ACTUAL ORGANIC SUBSTANCE

	B.t.u.
Cellulose and wood.....	6,500 to 7,800
Peat	7,800 to 11,500
Lignite, brown	11,500 to 13,000
Lignite, black, or sub-bituminous coal.....	13,000 to 14,000
Bituminous coal (mid-continental field).....	14,000 to 15,000
Bituminous coal (eastern field).....	15,000 to 16,000
Semi-anthracite and semi-bituminous.....	15,500 to 16,000
Anthracite	15,000 to 15,500

*Jour. Am. Chem. Soc. Vol. 26, p. 566.

This study has been carried still further by the Illinois State Geological Survey, and the extremes have been derived for the various seams as worked throughout the coal area of the State.

It is to be recalled that the geologists recognized 16 coal seams for Illinois, counting from the bottom of the coal measures upward. Only seven of these seams are of workable thickness. The numbering follows the geological order, and not that used in some localities, as at LaSalle, Bloomington, etc., where the number of the seam is that which resulted from the order of their development from the surface downward.

In table No. XIV a few illustrative examples are given of unit coal values. Complete tables covering all of the producing counties of the state have recently been published* from which these figures have been taken:

TABLE XIV

AVERAGE HEAT VALUE FOR UNIT COAL IN BRITISH THERMAL UNITS PER POUND

No.	County	Coal bed	Number of samples averaged	Average—B. t. u. "unit coal"
1	Sangamon.....	5	15	14424
2	Sangamon.....	6	5	14340
3	Macoupin.....	6	6	14310
4	Madison.....	6	18	14350
5	Vermilion.....	6	19	14597
6	Vermilion.....	7	9	14730
7	Williamson.....	6	5	14750

Calculation of Commercial Values:—The use which can be made of these "unit" values such as are shown in this table may be readily understood when it is remembered that each number represents material which is 100 per cent pure and that for each per cent of inert matter present, such as water and ash, there is a corresponding decrease in the number of heat units present. That is to say, if a coal has 20 per cent water and ash, then 80 per cent of the "unit" value will represent the heat units present per pound of coal as delivered. Indeed, it is possible by taking account of certain refinements already referred to, such as correction factors for sulphur and hydration of the shaly constituents, to make a calculation which will be of quite sufficient accuracy for basing bids and entering into contracts involving a guarantee as to heat values.

*Ill. State Geol. Survey. Bulletin No. 29. "Purchase and Sale of Illinois Coals on Specification" by S. W. Parr, 1914.

The method of calculation is exceedingly simple and is based on the following expression:

Let A = weight of ash per pound of coal.
 Let S = weight of sulphur per pound of coal.
 Then—

$$\text{“Dry” B.t.u.} = \text{“Unit” B.t.u.} \times [1.00 - (1.08A + 0.55S)] + 5000S.$$

To illustrate, take the “unit” value for coal from Vermilion County, Sample No. 6 in Table XIV. Suppose we wish to know what heat value can be guaranteed on deliveries from a mine of this group on the basis that we can furnish material averaging as the “dry coal,” 12 per cent ash, and 3 per cent sulphur, we will have our total non-combustible material corrected by the above formula as follows:

1.08A.....	12.96
0.55S.....	1.65
<hr/>	
Total.....	14.61
100% — 14.61% = 85.39%	
14730 × 85.39% = 12578	

In this calculation the sulphur has been neglected. It has a small heat value equal to 5000 times the weight of sulphur present or 50 times the percentage number, thus:

$$50 \times 3 = 150 \text{ units to be added to the above value, or}$$

12578
150
<hr/>
12728 B.t.u.

Deliveries from this mine, therefore, having ash, and sulphur as indicated above can be depended upon as carrying 12728 heat units per pound of “dry” coal, and this factor should be accurate within 100 units in 12000 or less than a variation of 1 per cent from values as they would be determined by direct reading from an instrument. Any other set of values for ash and sulphur would similarly admit of ready calculation and should be used as a basis for calculations involving guarantees of deliveries on a heat-unit basis. If the heat units on the “wet” coal basis are desired assuming, for example, a moisture factor of 15 per cent, the above value as derived for “dry” coal should be multiplied by .85, that is, 12728 B.t.u. × .85 = 10818 B.t.u. per pound of the “wet” coal, assuming a moisture factor of 15 per cent as indicated.

DIRECT DETERMINATION OF HEAT VALUES

The Berthier Test:.....The Berthier test is based on the property of carbon to reduce the oxide of lead at a red heat. The higher the percen-

tage of combustible present, the larger the button. One gram of coal is mixed with 2 oz. or 60 grams of litharge and heated to redness in a crucible. The weight of the button thus obtained is multiplied by the 421. The product represents theoretically the reducing power of the carbon in terms of British thermal units. It should be increased by about the value of the available hydrogen present. In Illinois coals this does not vary widely from 3.5 per cent, making the addition of a constant necessary of about 2000 B.t.u. The results thus obtained may vary from the truth by 300 to 800 units, or from 3 to 8 per cent. The method has historical rather than practical interest.

The *Lewis Thompson* calorimeter is a bell shaped receptacle for submerging water and containing within the bell a cartridge having a mixture of coal, 2 grams; with 22 grams of a mixture of potassium nitrate 3 parts, and potassium chlorate, 1 part.* According to Schorer-Kestner** this apparatus normally gives results that are in error by about 15 per cent. This apparatus also dates back to a time when a mere approx-



Fig. 11. Filling an Oxygen Bomb from a High-pressure Cylinder Supply
(Courtesy of the Standard Calorimeter Co., East Moline, Ill.)

imation to the correct values was all that seemed to be demanded by fuel users. At the present time a degree of exactness is required which was impossible with either of the methods just described.

There are two types of calorimeters using oxygen as a medium for carrying on the combustion,—those in which the oxygen is maintained

*For details of the Apparatus see *Fuel, Water and Gas Analysis*. By Kershaw.

***Jour. Soc. Chem. Ind.* Vol. 7, p. 869.

at atmospheric pressure and those using oxygen under approximately 25 atmospheres.

Of the first type, the best known perhaps are Fischer's, Carpenter's, W. Thompson's, etc., which conduct a current of oxygen into a chamber containing the fuel. The chief disadvantage results from imperfect combustion, especially with high ash coals due to fusion of the ash with consequent enclosure and protection of the carbonaceous matter from further oxidation.

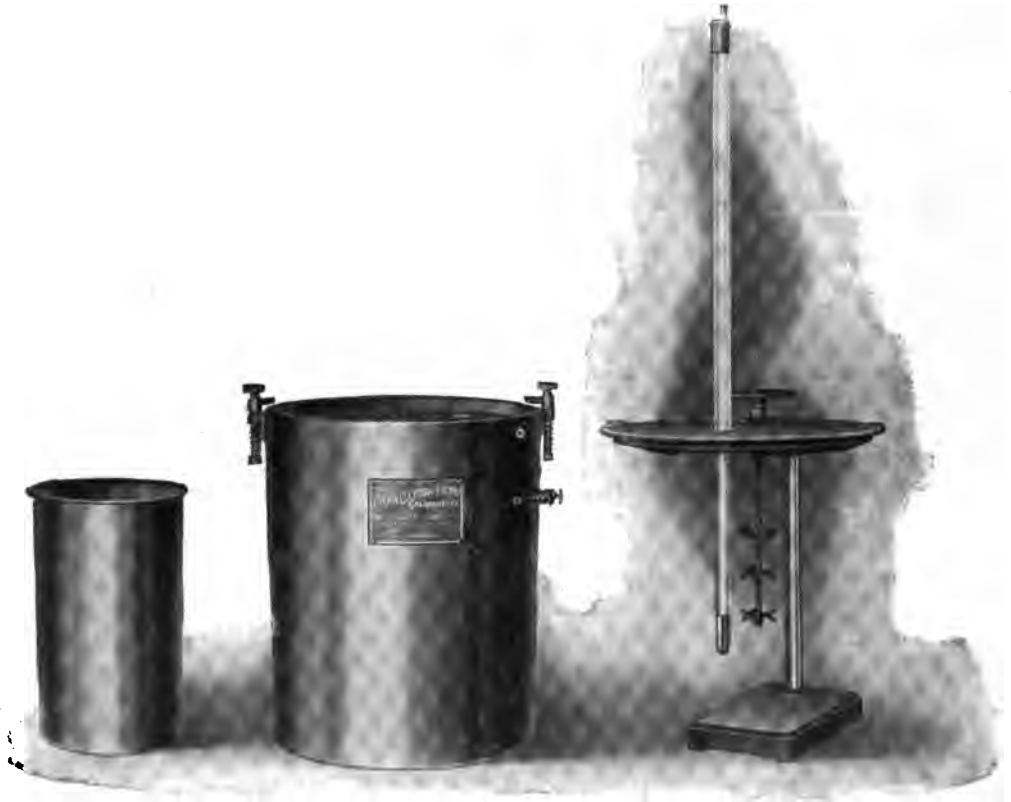

Fig. 12. Oxygen Calorimeter Dismantled

Oxygen Bomb Calorimeters.—Calorimeters using oxygen at approximately 25 atmospheres pressure are designated as of the Berthelot or Mahler type from the names of the investigators who were pioneers in their development and use. A typical bomb of this type is shown in Fig. 11 connected with the high pressure oxygen supply for charging. A carefully weighed amount of coal is held in a capsule within the bomb. The bomb after charging is placed in the can A, Fig. 12, and a

known quantity of water added. After placing in the insulated receptacle B, and putting in place the cover C, an equalization of temperatures is brought about by rotation of the stirrer. After ignition and equalization again of the temperature, the factors are at hand for deriving the heat value of the coal according to the formula:

$$\text{B.t.u.} = \frac{\text{rise} \times \text{total water}}{\text{Wt. of coal}}$$

For example, if one gram of coal were taken and the total water used, including the water equivalent of the apparatus, were 2400 gráms, then for a rise of say, 4° Fah. the heat value would be 9600 B.t.u. By this procedure, therefore, may be found the rise in temperature which a given weight of coal will impart to an equivalent weight of water, thus satisfying the conditions of the definition of the British thermal units per pound of fuel.

Radiation Corrections:—If the system containing the bomb and measured quantity of water is operated at a temperature above or below that of the room a gain or loss of heat will result due to radiation. This may be corrected for in a very accurate manner by taking the thermometer readings each minute for a preliminary period of five minutes and also for a final period of five minutes. The *rates of radiation change* thus obtained are incorporated into a formula covering the period of combustion and equalization of the system. Details of procedure and calculations are given under directions for manipulation (Part II, p. 111).

Adiabatic Insulation:—To avoid the necessity of accounting for radiation losses and eliminating possible errors, as also to simplify the matter of readings and calculations, various methods of insulation involving adiabatic conditions have been developed. To be thoroughly effective these methods should involve complete control over the temperature of the insulating part of the apparatus in such a way as to cause the temperature to rise coördinately with that of the combustion system. Such instruments are designated as adiabatic calorimeters. Their greater convenience of operation and possibilities of extreme accuracy are apparent.

Acid Values:—One other condition exists in the use of the Mahler type of calorimeter which requires consideration. Because of the use of pure oxygen at a high pressure and temperature, certain reactions take place which do not occur in the ordinary process of combustion. For example, a small amount of residual air present upon closing the instrument has free nitrogen which under the conditions of combustion is partially oxidized to N_2O_5 or with the moisture present in the bomb it becomes HNO_3 . Similarly the nitrogen of the coal burns to a greater

or less extent to HNO_3 . The sulphur in the coal which under ordinary conditions of combustion burns to SO_2 , in the calorimeter burns to SO_3 , or with the moisture present, to H_2SO_4 . These two highly corroding acids make it necessary to protect the interior surface of the bomb. This is accomplished by use of an enamel, by a spun lining of gold or platinum, or by constructing the bomb of an acid resisting alloy equivalent in that respect to gold or platinum. If such a precaution is disregarded, as for example, if the enamel type of protection becomes cracked and scaled off or if a lining of spun metal such as nickel is employed, the solvent property of the acids becomes active. There are two sources of error which result from such conditions,—one is the heat of solution resulting from the chemical action. This of course should not be credited to the heat content of the coal. The other is the lowering of the amount of free acid which thus escapes measurement and otherwise would be corrected for. In high sulphur coals of the Illinois type the error from this source may be of considerable moment.

Details of manipulation and procedure for taking account of the various corrections to be applied with the attending methods of calculation are given in connection with the laboratory directions in Part II.

Peroxide Calorimeter.—Another type of calorimeter is extensively used in which the coal is mixed with a chemical which will supply the oxygen to complete the combustion within a closed cartridge. This method is more conveniently available perhaps for technical work. The procedure is described under the directions for calorimetric measurements. (Part II, p. 98.)

The principles involved are as follows: Sodium peroxide, Na_2O_2 , when mixed with coal in suitable proportion and ignited, may be made to burn or react through an appreciable period of time but, instead of the formation of gaseous products as in the ordinary process of combustion, the CO_2 and H_2O unite with the chemical employed to form the carbonate and hydrate of sodium, which are solids. These reactions shown in detail are as follows:

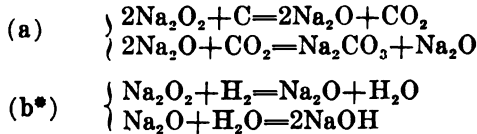

Of the total heat developed in the reactions under (a), 0.73 represents the heat combination between the carbon and oxygen. Also, under (b), the total heat of the reactions is made up of 73 parts, which includes

*The complete reactions involved are probably expressed by the equation— $\text{Na}_2\text{O}_2 + \text{Na}_2\text{O} + \text{O} + 4\text{H} = 4\text{NaOH}$. (See "The Constants of the Parr Calorimeter." Jour. of the Am. Chem. Soc., Vol. XIX, p., 1616).

the heat formed by the union of the hydrogen with the oxygen, and 27 parts, which represents the secondary reaction or combination of the water with the chemical. This distribution of heat values is fortunate for the reason that we may make the factor 0.73 a constant which represents the part of the total heat to be taken as the equivalent of the heat of ordinary combustion. Other corrections must be applied to the indicated rise in temperature as detailed in the method of operation (Part II, p. 101). A brief discussion having reference to the reason for applying the corrections is here given.

First.—The ignition is effected by an electrically heated fuse wire. The amount of heat introduced by the electric current and combustion of the wire is found to be .005° F.

Second.—The combination of the ash with the sodium peroxide, forming in the main sodium and aluminum silicates, is attended with a slight increment of temperature which is found by direct experiment to amount to 0.005° F for each per cent of ash present in the fuel.

Third.—The sulphur in ordinary combustion burns to sulphur dioxide, SO₂, while in the reaction with the chemical the ultimate result is Na₂SO₄. The difference in the heat resulting from the two reactions should be subtracted from the indicated temperature. The amount of the correction is determined by burning pure iron pyrites, FeS₂, in the apparatus and comparing the heat evolved with the accepted heat value for the combustion of an equivalent amount of sulphur to SO₂*. The difference is found to be equivalent to 0.010° F for each per cent of sulphur present in the coal.

Fourth.—For the more perfect combustion of all types of coal and also for supplying the seemingly needed free or nascent oxygen for the combustion of the hydrogen, an accelerator is used in conjunction with the sodium peroxide, preferably chlorate of potash, finely pulverized and dry. The heat of decomposition of this material plus the recombination of the free oxygen with the Na₂O resulting from the reactions with carbon amount to 0.270° F per gram of KClO₃ used. The indicated rise of temperature is, therefore, first corrected for the several components enumerated, and the corrected rise is used in the formula :

$$\text{B.t.u.} = \frac{r \times w \times 0.73}{C}$$

in which "r" is the corrected rise in temperature, "w" is the water equivalent of the water and metal of the apparatus, 2123.3 grams, and "C" is the weight of coal taken, 0.5 gram. This will give us the rise in degrees Fahrenheit or B.t.u. which an equal weight of coal will yield

*Idem, p. 1620.

upon combustion, provided the actual heat of combustion is imparted to an equivalent of water.

Since, in the above formula the factors for "w," "C," and the constant 0.73 occur in all cases, their resulting value becomes a constant equal to 3100. Thus,

$$\frac{2123.3 \times 0.73}{0.5} = 3100.$$

COMPOSITION OF ILLINOIS COALS

A recent survey carried on by the Illinois State Geological Survey in coöperation with the U. S. Bureau of Mines covered all of the coal producing counties of Illinois and included something over 100 mines. The analytical values for the coals from these mines have been averaged for the various counties and are assembled in Table No. XV. Where mining operations are carried on from different seams in the same county, the average for the single seam indicated is given separately and not for the county as a whole. Also, for the reason that some of the seams vary widely in character from north to south, the letters "N" or "S," are occasionally used to designate the general region from which the samples are taken. Similarly, since in some rather restricted localities a marked alteration in the seam occurs from East to West, the letters "E," and "W," are used as in Perry County, the letter "E" signifies for seam No. 6, East, and "W" west of the DuQuoin anticline.

Partial bibliography relating to coal calorimetry.

Lord and Somermeier, Ohio State Geological Survey, fourth series, Bulletin 9, p. 320.

Atwater, Jour. Am. Chem. Soc., Vol. 25, p. 659.

Parr, S. W., Jour. Am. Chem. Soc., Vol. 29, p. 1606.

Parr, S. W., Jour. Ind. & Eng'g. Chem., Vol. 1, No. 9, p. 673.

Investigations in the Use of the Bomb Calorimeter. By J. A. Fries. U. S. Dept. Ag. Bul. 94. 1907.

Coal, Its Composition, Analysis, etc. By E. E. Somermeier. 1912.

Technical Gas and Fuel Analysis. By A. H. White. 1914.

Bureau of Standards Scientific Paper No. 230. By H. C. Dickinson.

The Function of Nitrogen in the Bomb Calorimeter. By S. A. Register. Jour. Ind. and Eng. Chem., Vol. 6, p. 812.

Report of the Committee E-4 on Methods of Sampling and Analysis of Coal. Proc. Am. Soc. Testing Mat., Vol. X 14, p. 444; 1914. Also Jour. Ind. and Eng. Chem., Vol. V, p. 517; 1913.

TALBE No. XV.

AVERAGE ANALYTICAL AND HEAT VALUES FOR PRODUCING COUNTIES IN ILLINOIS.

*COMPILED FROM BULLETIN No. 29 ILL. STATE GEOL. SURVEY.

Table No.	County	Geological Seam	Total Moisture	Vol-atile Matter	Fixed Carbon	Ash	Sul-phur	Carbon Diox-ide	B.t.u.	"Unit Coal"
1	Bureau	2 N	16.27 Dry	38.35 45.80	38.00 45.39	7.88 8.81	2.98 3.50	.89 1.40	10888 12997	14477
2	Christian	1 O	11.81 Dry	38.89 43.85	40.94 46.16	8.86 9.99	2.35 2.65	.48 .48	11602 13081	14717
3	Clinton	6 S	12.62 Dry	37.08 42.45	40.10 45.90	10.20 11.67	3.90 4.46	.66 .75	10796 12355	14290
4	Franklin	6 S	9.04 Dry	34.62 38.06	47.78 52.53	8.66 9.41	1.45 1.59	.44 .48	11837 13013	14538
5	Fulton	5 N	16.16 Dry	36.27 43.26	37.09 44.24	10.48 12.50	3.14 3.74	1.33 1.59	10363 12361	14416
6	Gallatin	5 S	4.30 Dry	35.93 37.54	49.08 51.29	10.69 11.17	3.79 3.96	.24 .25	12616 13183	15109
7	Gallatin	6 S	7.54 Dry	34.96 37.81	45.68 49.41	11.82 12.78	4.34 4.70	.23 .25	11916 12888	15136
8	Jackson	2 S	9.28 Dry	33.98 37.46	51.02 56.24	5.72 6.30	1.29 1.42	.29 .32	12488 13765	14818
9	Jackson	6 S	8.96 Dry	34.44 37.83	46.40 50.97	10.20 11.20	2.65 2.91	.40 .44	11609 12751	14608
10	La Salle	2 O	15.70 Dry	39.54 46.91	36.17 42.89	8.59 10.20	3.48 4.12	.96 1.15	10731 12723	14444
11	La Salle	5 O	14.76 Dry	41.83 48.49	34.26 40.19	9.65 11.32	3.38 3.97	.61 .71	10692 12543	14397
12	La Salle	7 O	13.56 Dry	40.87 47.28	37.80 43.73	7.77 8.99	3.68 4.26	.17 .20	11347 13127	14685
13	Logan	5 O	14.20 Dry	37.19 43.35	37.44 43.40	11.37 13.25	3.34 3.89	1.42 1.66	10490 12226	14400
14	Macon	5 O	14.15 Dry	36.63 42.73	38.83 45.23	10.34 12.04	3.57 4.16	.52 .60	10661 12418	419 14
15	Macoupla	6 O	13.88 Dry	38.20 44.86	37.75 43.83	10.17 11.81	4.31 5.00	.34 .39	10657 12575	14349
16	Madison	6 S	13.47 Dry	38.59 44.60	38.03 43.95	9.91 11.45	4.22 4.88	.42 .49	10760 12435	14370
17	Marshall	2 N	15.10 Dry	39.06 46.01	38.68 45.56	7.16 8.43	2.79 3.23	.48 .56	11315 13327	14796
18	Marion	6 S	10.79 Dry	37.53 42.07	40.46 45.35	11.22 12.58	3.96 4.44	.45 .51	11069 12408	14511
19	Menard	5 O	17.33 Dry	35.88 43.40	38.62 46.72	8.17 9.88	3.44 4.16	.50 .60	10499 12700	14478
20	Mercer	1 W	15.58 Dry	39.17 46.40	35.80 42.41	9.45 11.19	4.69 5.55	.58 .63	10673 12643	14546
21	Montgomery	6 O	14.15 Dry	36.88 42.96	39.14 45.59	9.83 11.45	3.84 4.47	.70 .83	10642 12396	14290
22	Moultrie	6 C	6.83 Dry	39.15 42.02	42.32 45.42	11.70 12.56	4.02 4.31	.57 .61	11877 12748	14882
23	Peoria	5 O	14.96 Dry	36.65 43.10	36.99 43.49	11.40 13.40	3.26 3.83	1.50 1.77	10506 12354	14614
24	Perry	6 O	9.92 Dry	32.72 36.81	46.97 52.15	10.39 11.53	1.92 .02	.25 .28	11335 12583	14407
25	Perry	6 W	11.00 Dry	36.75 41.29	41.97 47.16	10.28 11.55	3.36 3.78	.56 .63	11087 12457	14359
26	Randolph	6 S	11.13 Dry	37.28 41.95	40.14 45.17	11.45 12.89	4.24 4.77	.58 .65	10855 12214	14351
27	Saline	5 S	6.92 Dry	35.44 38.08	49.06 52.70	8.58 9.22	3.76 4.04	.39 .42	12314 13229	14794
28	Sangamon	5 O	14.35 Dry	37.30 43.55	37.57 43.86	10.78 12.59	4.16 4.86	.59 .69	10555 12323	14415
29	St. Clair	6 S	11.25 Dry	39.57 44.59	38.89 43.26	10.79 12.15	3.99 4.50	.63 .71	11028 12426	14457
30	Tazewell	5 O	14.88 Dry	37.74 44.08	38.23 44.65	9.66 11.28	3.10 3.62	1.20 1.40	10809 12624	14496
31	Vermillion	6 C	14.45 Dry	35.88 41.94	40.33 47.14	9.34 10.92	2.55 2.98	.75 .88	10920 12764	14575
32	Vermillion	7 C	12.99 Dry	38.28 44.00	38.75 44.53	9.98 11.47	2.93 3.37	.56 .64	11143 12307	14740
33	Williamson	6 S	9.31 Dry	33.38 36.81	48.90 53.92	8.41 9.27	1.54 1.70	.36 .40	11913 13136	14655

PURCHASE AND SALE OF COAL UNDER SPECIFICATION¹

Present-day tendencies relating to the basis for coal contracts are reflected in the following quotations:

When a proper sample of the coal is secured, the chemical analyses and calorimeter determinations for B.t.u. are a better guide to the value of the coal than are one or two boiler tests for the same purpose.²

The purchase of coal under specification is as advantageous as a definite understanding regarding the quality and other features of any other product, or of a building operation or engineering project. The man who buys under specification gets what he pays for and pays for what he gets.³

The heating value expressed in British thermal units per pound is the most direct measure of the value of coal. Contracts made on what is termed the "heat-unit basis" provide therefore that the amount of money paid shall be in direct proportion to the number of heat units delivered. It is evident that the number of heat units varies inversely with the quantity of ash and moisture. That the bidder should be thoroughly familiar with these factors in their application to the coal which he proposes to furnish is self-evident. A thorough understanding of the methods of awarding contracts is also essential to the dealer who proposes to enter bids on a competitive basis.

Use of a Double Standard of Reference:—The cost of a given lot of coal must be based upon the weight of the material. The sample taken should represent the coal "as delivered," and, as already emphasized, moisture changes in the sample are to be carefully guarded against. Variations in quality are taken into account by varying the price per ton directly in proportion to the number of heat units delivered. In the award of contracts and in computations for payment, therefore, the calculations are based upon the heat units per pound in the coal "as delivered."

Concerning the ash, if there were no other effect produced by ash variations than a corresponding variation in the heat units then no further account would be taken of that constituent since it would be taken care of in the calculations involving the heat units. However, on account of the expense in handling, and because of a lowering of efficiency resulting from excessive ash, an additional modification in price is made for this constituent. For greater convenience where comparisons are involved and to eliminate the moisture variable, it is found preferable

¹Adapted from Illinois State Geological Survey. Bulletin 29. By S. W. Parr, 1914.

²The Purchase of Coal: The Arthur D. Little Inc. Laboratory of Engineering Chemistry, pages 10 and 11, 1909.

³Pope, G. S., Purchase of coal by the government under specifications: U. S. Geol. Survey Bull. 428, page 10, 1910.

to refer the ash values to the "dry-coal" basis. This involves the use of a double standard of reference; the heat units are referred to the "wet" or "as-received" basis and the ash is referred to the "dry" or "moisture-free" basis.

The methods of applying the various conditions involved, in the purchase of coal by the Illinois State Board of Administration, are given as follows:

Bids and Awards:—(1). Bidders are required to specify their coal offered in terms of British thermal units "as-received," but ash is specified on the "dry-coal" basis. These values become the standards for the coal of the successful bidder.

(2). In order to compare bids, all proposals are adjusted to a common basis. The method used is to merge all three variables—ash, calorific value, and the price bid per ton—into one figure. This figure will be the cost in cents of 1,000,000 British thermal units and is derived as follows:

(a). All bids are adjusted to the same ash percentage by selecting as the standard for comparison the proposal that offers coal containing the highest percentage of ash. Each 1 per cent of ash content below that of this standard will be assumed to have a positive value of 2 cents per ton, and accordingly the price will be decreased 2 cents, which is the amount of premium allowed under the contract for 1 per cent less ash than the standard established in the contract. Fractions of a per cent will be given proportional values. The adjusted bids will be figured to the nearest tenth of a cent.

(b). On the basis of the adjusted price, allowance will then be made for the varying heat values by computing the cost of 1,000,000 British thermal units for each coal offered. This determination will be made by multiplying the guaranteed British thermal units per pound by 2,000 and dividing the product by 1,000,000. This factor gives the guaranteed number of million units per ton of delivered coal. Dividing the adjusted price as found under (a) by this factor gives the cost per million heat units.

A convenient form for tabulating bids to indicate the various factors entering into the final computation of cost is shown below.

TABLE XVI
CONVENIENT FORM FOR TABULATING BIDS

No.	Coal offered	Guarantees		Price per ton 2000 lbs.		Computed cost in cents per 1,000,000 B. t. u. f (b)
		Ash in "dry coal" (per cent)	B. t. u. "as received"	As bid	As adjusted for ash f (a)	
A	Vermilion Co. Screenings.....	17	10300	1.50	1.50	7.3
B	Sangamon Co. Screenings.....	16	10400	1.35	1.33	6.4
C	Williamson Co. Screenings.....	14	12500	2.00	1.94	7.8

Price and Payment:—Payment for coal specified in the proposal will be made upon the basis of the price therein named, which has been corrected for variations in heating value and ash from the standard specified in the contract, as follows:

(a). Considering the guaranteed heat units on the "as-received" basis, the correction in price will be a proportional one and is determined by the following formula:

$$\frac{\text{B.t.u., delivered}}{\text{B.t.u., guaranteed}} \times \text{bid price} = \text{price corrected for B.t.u.}$$

The correction is figured to the nearest tenth of a cent.

(b). For all coal that by analysis contains less ash on a dry-coal basis than the percentage guaranteed, a premium of 2 cents per ton for each whole per cent less will be paid. An increase in the ash content of 2 per cent above the standard established by the contractor is tolerated without exacting a penalty. When this excess is greater than 2 per cent, deductions are made in accordance with the following table:

TABLE XVII
SHOWING DEDUCTIONS FOR EXCESS ASH*

Ash as established in proposal	No deduction for limits below	Cents per ton to be deducted							Maximum limits for ash
		2	4	7	12	18	25	35	
		Percentage of ash in "dry coal"							
<i>Percent</i>									
5.....	7	7- 8	8- 9	9-10	10-11	11-12	12-13	13-14	12
6.....	8	8- 9	9-10	10-11	11-12	12-13	13-14	14-15	13
7.....	9	9-10	10-11	11-12	12-13	13-14	14-15	15-16	14
8.....	10	10-11	11-12	12-13	13-14	14-15	15-16	16-17	14
9.....	11	11-12	12-13	13-14	14-15	15-16	16-17	17-18	15
10.....	12	12-13	13-14	14-15	15-16	16-17	17-18	16
11.....	13	13-14	14-15	15-16	16-17	17-18	18-19	16
12.....	14	14-15	15-16	16-17	17-18	18-19	19-20	17
13.....	15	15-16	16-17	17-18	18-19	19-20	20-21	18
14.....	16	16-17	17-18	18-19	19-20	20-21	21-22	19
15.....	17	17-18	18-19	19-20	20-21	21-22	19
16.....	18	18-19	19-20	20-21	21-22	22-23	20
17.....	19	19-20	20-21	21-22	22-23	21
18.....	20	20-21	21-22	22-23	22

As an example of the method of determining the deduction in cents per ton of coal containing ash exceeding the standard by more than 2 per cent, suppose coal delivered on a contract guaranteeing 10 per cent ash on the "dry-coal" basis shows by analysis between 14.01 and 15 per cent (both inclusive), or, for instance, 14.55 per cent, the deduction according to the table is 7 cents per ton (reading to the right on line beginning with 10 per cent on the extreme left, which in this case is the standard, to the column containing "14.01-15," the deduction at the top of this column is seen to be 7 cents).

NOTE—If the ash standard is an uneven percentage, the table will be revised in order to determine deductions on account of excessive ash. For example, if the ash standard is 6.53 per cent, each percentage value beginning with 6 in the left-hand column and all figures in the line reading to the right of 6 will be increased by 0.53. There would be no deduc-

*Bulletin, 378, United States Geological Survey, Results of Purchasing Coal under Government Specifications.

tion then in the price of ash in delivered coal up to and including 8.53 per cent, whereas for coal having an ash content, for instance, between 11.54 and 12.53 per cent the deduction would be 12 cents per ton.

The Formulation of Proposals:—The coal operator should know what guarantees he can maintain in making up his bid. The purchaser should be able to determine the likelihood of the operator being able to fulfill his guarantee without excessive penalties. Where unit coal values are known for a particular mine or district this information is a simple matter of calculation and has already been explained on p. 52. The Table No. XV of average unit values for the producing counties will furnish the initial data.

THE COMBUSTION OF COAL

General Principles:—The difficulties attending the complete combustion of bituminous coal are directly related to the volatile matter present. The showing of large volumes of smoke, therefore, is a sure sign of serious loss of the fuel constituents. The underlying principles furnish a sufficient explanation for the losses which accompany heavy smoke. A brief enumeration, therefore, is here given:

(a) At temperatures below 750°F about one-half of the total volatile matter of bituminous coal is discharged.

(b) The first distillates at these lower temperatures are composed chiefly of the so-called heavy hydrocarbons, ethylene, propylene, benzene, etc., including some compounds which are light oils at ordinary temperature.

(c) Under the most favorable conditions it is difficult to burn these compounds without producing a smoky flame, a prerequisite being a much larger mixture of air than that required for the distillates which come off at the higher temperatures, mainly methane (CH_4) and hydrogen.

(d) A high percentage of moisture, which is also discharged simultaneously with the heavy hydrocarbons, accentuates the difficulty by sudden expansion into steam and consequent displacement of air, as well as by lowering the temperature of the combustion chamber while the process of vaporization is proceeding.

From this enumeration, it is evident that to discharge these first distillates into a relatively cooler zone emphasizes the unfavorable conditions for combustion and results also in a condensation of some of the compounds, all of which is made evident by the appearance of dense volumes of smoke. This is always the result with house-heating appliances and is more or less evident with all steam-generating devices which are fired intermittently.

The mechanical or physical features essential to smokeless combustion are now well understood as the result of the elaborate investigations

carried on by Mr. W. L. Abbott and Mr. A. Bement at the Chicago Edison plant. The two fundamental elements involved are:—First, a continuous accession of fuel by some system of automatic stoking; and, second, the discharge of the volatile products into a highly heated combustion zone for accomplishing both the necessary admixture of air and the completion of the oxidation processes.

STORAGE, WEATHERING, AND SPONTANEOUS COMBUSTION

Deterioration:—Coal is subject to deterioration from the time of breaking out at the mine until used. These losses, however, are relatively small. A sudden drop occurs in the first week or two, due no doubt to the liberation of certain of the hydrocarbons. Subsequent losses are more largely due to the absorption of oxygen and the formation of humic compounds which are part of the subsequent coal texture. The cut shown herewith is typical and illustrates the kind and amount of the losses over the space of one year's storage.

Perhaps even more serious than the loss by weathering is the disintegration or slaking which takes place, whereby the coal is reduced in size. It is thus rendered more difficult to maintain a proper circulation of air through the fuel bed. The matter of weathering is discussed in detail in Bulletin No. 38 of the Illinois Engineering Experiment Station.

Spontaneous Combustion:—All coals of the bituminous type are subject to spontaneous combustion. A detailed study of the causes has been made in Bulletin No. 46 of the Illinois Engineering Experiment Station. Briefly summarized, they are as follows:

1. The oxidation of coal is continuous over a wide range of time and conditions, and begins with the freshly-mined coal at ordinary temperatures. A number of oxidation processes are involved which are more or less distinct in character, some being relatively slow and moderate in form, while others are rapid and vigorous in their action.

2. In general, we may say that for a given coal a point exists as indicated by the temperature, below which oxidation is not ultimately destructive and its continuance is dependent upon certain accessory conditions which, if withdrawn, the oxidation ceases. On the other hand, above this critical point, which is best indicated by temperatures, oxidation is ultimately destructive and is characterized by the fact that it does not depend for its continuance upon external conditions, but is self-propelling or autogenous.

3. The point of outogenous oxidation, while varying for different conditions, may be indicated by temperatures of the mass ranging from 200° to 275°C, depending to a great extent upon the fineness of division. The phenomenon of fire or actual kindling does not occur until a much higher temperature is reached, usually beyond 350°C.

4. The temperature at which autogenous oxidation begins is the sum of numerous temperature components, each one of which, either because of its own contribution to the total heat quantity or because of its function as a booster for chemical activities, must be looked upon as a dangerous factor tending directly to the ultimate result of active combustion throughout the mass. An enumeration of the more important elements which contribute towards this end are the following:

a.—External Sources of Heat:—Oxidation, especially of the lower or moderate form, is greatly accelerated and in certain phases directly dependent upon an increase of temperature. What may be termed external or physical sources of heat, and thus presumably avoidable, are suggested by the following:

(1) Contact of the mass with steam pipes, hot walls or floors under which are placed heat conduits of any sort.

(2) The heat of impact or pressure due to the method of unloading or to the depth of piling.

(3) Climatic or seasonal temperature at the time of storage.

(4) The direct absorption of heat from the sun or from reflecting surfaces.

b.—Fineness of Division:—Coal in a fine state of division presents a very much larger surface and brings a much larger quantity of reacting substances in contact with oxygen than when in solid masses. Under these conditions, with a condensation or accumulation of relatively large amounts of oxygen immediately surrounding or in contact with the particles of carbonaceous matter, the circumstances are exceedingly favorable for rapid oxidation upon the arrival of the mass to a suitable temperature. But, more especially does this fineness of division facilitate the initial form of oxidation described under *c* below.

c.—Easily Oxidizable Compounds:—An initial stage of oxidation exists in bituminous coals which does not result in the formation of carbon oxide. There are present in coals of this type unsaturated compounds which have a marked avidity for oxygen at ordinary temperatures, the products being humic acid or other fixed constituents of the coal texture. Coals vary widely in this matter and it has been proposed by some to regard this property as an index of the liability to spontaneous combustion. It is, however, very largely dependent upon the freshness of the coal and upon the fineness of division, (See, under *b* above), and should be looked upon as a contributing factor, though in coals of the Illinois type at least, with their high per cent of sulphur, this action should doubtless be considered second in importance to that of iron pyrites.

d.—Iron Pyrites:—The presence of sulphur in the form of iron pyrites is a positive source of heat due to the reaction between sulphur and oxygen. Here again rapidity of oxidation is directly dependent

upon fineness of division. Since coals of the Mid-Continental field especially have a much higher earthy or ash content in the fine material, and since iron pyrites is a large component of this substance, it follows that the presence of dust or duff in all coals of the Illinois type is a positive source of danger. Since coals of the Illinois or Mid-Continental field have in the larger number of cases iron pyrites averaging over 5 per cent or as sulphur above $2\frac{1}{2}$ per cent, the heat increment from the oxidation of only $\frac{1}{5}$ of this material is sufficient to raise the temperature of the mass approximately 70° , assuming that there is no loss by radiation. Under usual conditions, and especially considering the greatly accelerated rate of chemical activity accompanying a rise of temperature, this oxidation may proceed with such rapidity that the heating up of the mass will be but little affected by the loss of heat due to radiation, except in relatively shallow piles. Coals of low sulphur content or such as do not have sulphur greatly in excess of, say $1\frac{1}{2}$ per cent are popularly supposed to be immune from heating, but no method of selection or hand-picking at the mine can eliminate all of the iron pyrites. Lumps of coal, to all outward appearance of good texture, may have nodules or detached bands of iron pyrites. These become centers of activity and with the addition of moisture such coal will have many scattered spots where heating begins. If fine coal is mixed in with the coarse, the difficulty is accentuated. Doubtless a complete separation of fine and lump material in such cases would lessen the danger.

e.—*Moisture*.—Moisture, while essential to pyritic oxidation, is given separate mention because its importance is apt to be underestimated. Any coal with pyritic conditions as above mentioned will be facilitated in that action by moisture. It is to be noted in this connection that the normal water content or vein moisture of coals in this central region is rarely below 10 per cent and ranges usually from 12 per cent to 15 per cent. The presence of such water must be borne in mind in considering the likelihood of chemical activity on the part of the pyrites present.

f.—*The Oxidation of Carbon and Hydrogen*.—A third stage of oxidation of the carbonaceous material exists by reason of the property of certain of the hydrocarbon compounds of coal to oxidize with the formation of CO_2 and H_2O at temperatures in excess of 120° to 140° . Though this type of oxidation does not take place appreciably at ordinary temperatures, it must be looked upon as an exceedingly dangerous stage in the process of oxidation, owing to the very much higher quantity of heat which is discharged by the oxidation of carbon and hydrogen; so that the temperature of autogenous action, though ordinarily occurring at a higher point by 100° or more, may be quickly attained as a result of this form of oxidation. Any initial heat increments, therefore, which threaten

to bring the chemical activities along to the point where the oxidation processes invade the carbonaceous material in this manner must be looked upon as dangerous. For example, any of the initial or contributory processes which result in raising the temperature of the mass 50°

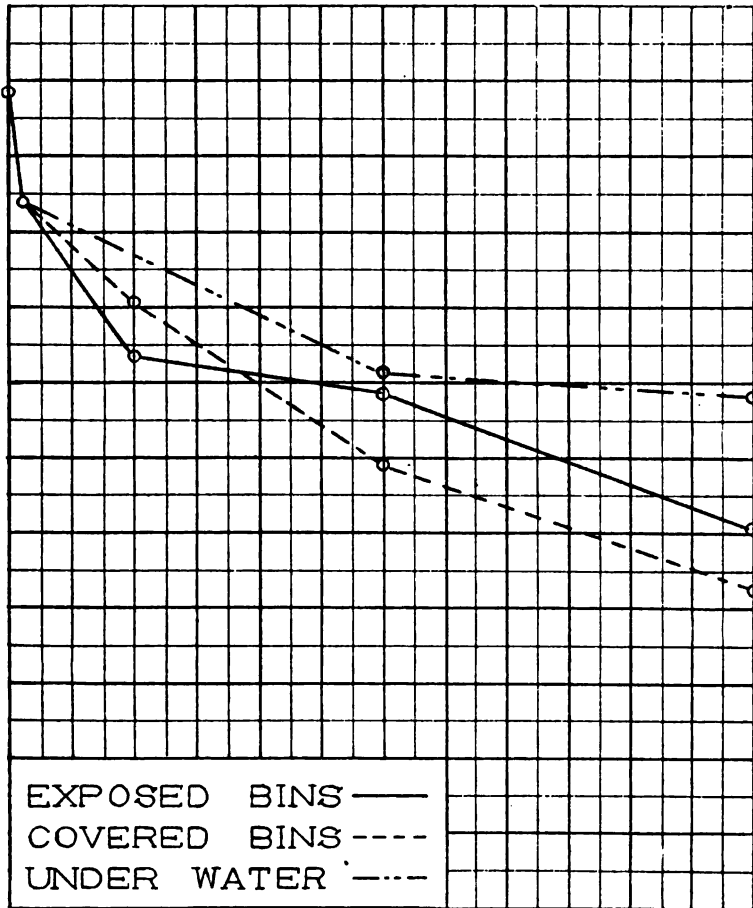

FIG. 13. VERMILION COUNTY, ILLINOIS, SCREENINGS SHOWING THE LOSS IN HEAT VALUE FOR THE FIRST TWO WEEKS, AND FOR EACH MONTH FOLLOWING THROUGHOUT THE YEAR

above the ordinary temperature would, in all probability, have enough material of the sort involved in such action to continue the activity until another 50° had been added, which would thereby attain to the condition wherein this third stage of oxidation would begin.

g.—Autogenous Oxidation.—The fourth stage of oxidation may be indicated as occurring at temperatures above 200° to 275° and differs from the previous stages in that the action is autogenous and not dependent upon other sources of heat to keep up the reacting temperature. Activity in this stage is further accelerated by the fact that above 300° the decomposition of the coal begins which is exothermic in character, thereby contributing somewhat to a further increase in temperature. The ignition temperature is reached at a point still further along, usually in excess of 300° to 400°C .

Storage Methods.—The above formulation of the various stages and types of oxidation clearly indicates the principles which must be observed in any attempt at the prevention of spontaneous combustion. The following enumeration, therefore, of preventive or precautionary measures is to be considered as suggestive rather than complete in character:

First, The avoidance of external sources of heat which may in any way contribute toward increasing the temperature of the mass is a first and prime essential.

Second, There must be an elimination of coal dust or finely-divided material. This will reduce to a minimum the initial oxidation processes of both the carbonaceous matter and the iron pyrites. These lower forms of oxidation are to be looked upon as boosters, without which it would be impossible for the more active and destructive activities to become operative.

Third, Dryness in storage and a continuation of the dry state, together with an absence of finely-divided material, would practically eliminate the oxidation of the iron pyrites. The drenching down with water of heating piles, where the sulphur content is high and uniformly distributed, accentuates the difficulty. Where pyritic activity is localized in spots or is so small in amount as to reach a possible exhaustion, the drenching with water may check the heating or prolong the action so that oxidation of the carbonaceous matter does not get under way to a serious extent. In such cases, however, there is no ultimate safety except in the removal of the heated zones.

Fourth, The submerging of coal, it is very evident, will eliminate all of the elements which contribute towards the initial temperatures. As to its industrial practicability, it can best be determined by actual experience.

Other processes may be suggested by the formulation of the principles involved. Such, for example, would be the distribution throughout the coal of cooling pipes through which a liquid would circulate having a lower temperature than the mass. This would serve to carry away any accumulation of heat and confine the oxidation to the lower stages only. On the contrary, the proposition sometimes made to provide cir-

culating passages for the transmission of air currents is of questionable value, since it may result in the contribution of more heat by the added accessibility of oxygen than will be carried away by the movement of the air.

CHAPTER III

FLUE GAS

Gas Volumes:—Air has the composition by volume of 20.78 per cent of oxygen and 79.22 per cent of nitrogen. In passing through the fuel bed the nitrogen is unchanged, being chemically inactive, and proceeds into the flue spaces in the same form in which it entered the furnace. The oxygen, on the contrary, enters into chemical reaction, combining with the carbon to form CO_2 and CO and with the hydrogen to form H_2O . As in all chemical processes, an excess of the reagent must be present in order to accomplish a rapid and complete reaction. There will always be found, therefore, in the flue gases a very considerable amount of excess or unused oxygen. The essential constituents, therefore, to be determined in the analysis of flue gases are

- (1) CO_2
- (2) Oxygen
- (3) CO
- (4) Nitrogen (by diff.)

In the combustion of carbon, the reaction which occurs may be represented by the formula $\text{C} + \text{O}_2 = \text{CO}_2$. This means that for each volume of oxygen one volume of CO_2 results. If, therefore, pure carbon were burned and the exact amount of air were supplied to completely represent the volumes indicated in the above equation, the resulting flue gas would be composed of 20.78 per cent of CO_2 and 79.22 per cent of nitrogen. This, therefore, would represent the extreme limit of theoretical possibility as to the percentage of the volume of CO_2 in such a flue gas. However, from the principal already stated as to the necessity of an excess of reagent, the rapid and complete oxidation of the carbon can only be effected by having an excess of oxygen, at least 50 per cent more than that utilized in the combustion, and even at this ratio the oxygen would begin to be sufficiently low in amount to result in the formation of a very considerable quantity of CO . From actual experience it would seem that a content of CO_2 in the flue gases of, say, 12 per cent approaches the limit of practicability, while doubtless from 8 to 10 per cent of CO_2 would represent conditions which are above the average in practice.

It should be borne in mind also that while carbon constitutes the larger part of the fuel content, the combustion of hydrogen (which on

the average represents from 3 to 4 per cent of the coal), would be represented by the formula

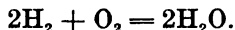

That is, one volume of oxygen results in two volumes of water vapor. Now, since in the process of analysis the water vapor condenses and does not appear in the results, it must follow that the nitrogen which accompanied the original oxygen into the furnace in this case is left alone without an accompaniment of gaseous product corresponding to the CO_2 as in the case of the combustion of carbon. To this extent, therefore, the ratio of theoretical CO_2 in the flue gases is diminished. From these considerations it will appear that the uses that may be made of the constituents are:—First, a very fair estimate of efficiency of the firing may be obtained from the percentage content of CO_2 in the flue gases. If, for example, it is known that for the boiler setting and equipment of a given furnace, it is capable of carrying on combustion to an extent which will be represented by 10 per cent of CO_2 in the flue gases, then when the flue gases show only 5 per cent of this constituent, there is evidence of carelessness in firing which is capable of correction.

Calculations:—The flue gas constituents and temperatures afford a basis for calculating efficiencies and heat losses. Three general features are usually included as follows:

- (a) The number of pounds of air entering per pound of fuel.
- (b) The ratio of air entering the grate to the air used.
- (c) The loss of heat passing up the chimney.

(a) *Pounds of Air Entering per Pound of Coal:*—The gram molecule of any gas, that is, the molecular weight of the gas in grams, has a definite volume and is the same for all gases; namely, 22.4 liters at standard temperature and pressure. For example 44 grams of CO_2 have a volume of 22.4 L.; 32 grams of O_2 have a volume of 22.4 L., etc. In a mixture of gases, therefore, the weight of each constituent, W , in 22.4 L. equals the molecular weight \times the percentage present thus:—

$$(1) \quad W = \text{mol. wt. of component} \times \text{per cent.}$$

In arriving at the weight of air entering the grate, the weight of the total nitrogen will give the most direct factor for calculating the air. For example, making use of equation (1) the weight of nitrogen, W^1 , in a gram-molecule-volume would be:

$$W^1 = 28 \times \text{per cent } \text{N}_2$$

In order to refer the weight of nitrogen present to a unit quantity of fuel, we shall need to determine, first the amount of pure carbon involved in the production of the unit volume of flue gas. This can be readily accomplished by deriving the weight of carbon in the gas and making one gram of carbon the unit of reference. For example, 12/44 of the CO_2 and 12/28 of the CO present is carbon.

If we let C represent the weight of carbon in the unit volume, then

$$C = 12/44 \times 44 \text{ CO}_2 + 12/28 \times 28 \text{ CO}$$

hence

$$C = 12 (\text{CO}_2 + \text{CO})$$

If, therefore, C represents the number of grams of carbon which deliver a flue gas with W^1 grams of nitrogen, then the weight of nitrogen per gram of carbon burned is $\frac{W^1}{C}$ or in terms of the assigned values,

$$(2) \quad W^1 = \frac{28 \text{ N}_2}{12 (\text{CO}_2 + \text{CO})} \quad \text{or} \quad \frac{7 \text{ N}_2}{3 (\text{CO}_2 + \text{CO})}$$

Assuming for illustration a chimney gas of the following composition:—

CO ₂	10. %
O ₂	8. %
CO5%
N ₂	81.5%

resulting from the combustion of a coal having 70 per cent of carbon exclusive of the carbon lost in the ash. Then by substituting these values in equation (1) we have:

$$W^1 = \frac{7 \times 81.5}{3 \times (10 + 5)} = 18.11 \text{ grams N}_2$$

That is, 18.11 grams nitrogen in the flue gases accompany the combustion of 1 gram of carbon. Similarly there would be 18.11 *pounds* of nitrogen in the flue gases from 1 *pound* of carbon, and for a coal of 70% carbon the weight would be $.70 \times 18.11 = 12.68$ pounds N₂. Since nitrogen passes through the furnace unchanged the calculation to the equivalent weight of air entering is,—

$$77 : 100 :: 12.68 : x$$

$$x = 16.47$$

Hence the weight of air entering per pound of coal is 16.47 pounds.

(b) *Ratio of Air Entering to Air Used:*—From the discussion under (a) the weight of oxygen per pound of carbon would be represented by the expression,—

$$(3) \quad W^1 = \frac{32 \text{ O}_2}{12 (\text{CO}_2 + \text{CO})} \quad \text{or} \quad \frac{8 \text{ O}_2}{3 (\text{CO}_2 + \text{CO})}$$

Substituting the values indicated under (a) we have

$$W^1 = \frac{8 \times 8}{3 (10 + .5)} = 2.03$$

and for a coal having 70% of carbon the weight would be 1.42 pounds per pound of coal. Calculating the oxygen to the equivalent of air,—

$$23 : 100 :: 1.42 : x \\ x = 6.17$$

Hence the weight of air passing through unused is 6.17 pounds per pound of coal.

From (a) and (b) therefore

Total air entering	16.47 pounds
Air unused	6.17 “
Air used	10.30 “

$$\frac{16.47}{10.30} = 1.60 \quad \text{Ratio of air entering to air used}$$

(c) *The Loss of Heat Passing Up the Chimney*.—The factors which enter into the calculation of heat losses in chimney gases are (1) the weight of the flue gas per pound of fuel, (2) the specific heat in B.t.u. per pound, and (3) the rise in temperature or difference in temperatures ($t - t^1$) between the entering air and the gases as they leave the furnace.

(1) The weight of the gas per pound of fuel may be readily derived from the formula for W as developed under (a) and (b) above. Letting W_v represent the weight of the mixed gases per pound of pure carbon, then by a similar procedure to that shown in equation (2) under (a) and equation (3) under (b) we would have for the total weight of all of the components per pound of carbon:

$$(4) \quad W_v = \frac{11 \text{ CO}_2 + 8 \text{ O}_2 + 7 \text{ CO} + 7 \text{ N}_2}{3 (\text{CO}_2 + \text{CO})}$$

Or, since $\text{CO} + \text{N}_2 = 100 - \text{CO}_2 - \text{O}_2$ this expression may be still further simplified to read:

$$(5) \quad W_v = \frac{4 \text{ CO}_2 + \text{O}_2 + 700}{3 (\text{CO}_2 + \text{CO})}$$

Assuming the coal used as in (a) and (b) to have 70 per cent of carbon (the carbon of the ash having been subtracted), then by substituting the percentage values for the chimney gas as already indicated and multi-

plying by .70 we would have the weight of gases per pound of fuel:

$$W = \frac{4 \times 10 + 8 + 700}{3(10 + 0.5)} \times .70 = 16.62$$

Therefore for (1)

$$W = 16.62 \text{ pounds dry gases per pound of fuel.}$$

(2) The specific heats of the various components, at constant pressure in B.t.u. per pound, calculated for the interval 60°F - 600°F,

$$\text{CO}_2 = 0.222$$

$$\text{O}_2 = .217$$

$$\text{CO} = .245$$

$$\text{N}_2 = .2407$$

$$\text{H}_2\text{O} = .4673$$

From which it appears that an average specific heat of 0.24 for all the constituents exclusive of water vapor may properly be applied. Assuming, therefore, the $(t - t')$ values of 60° entering and 600° leaving, we have a total loss L for the dry gases thus:

$$L = 16.62 \times 0.24 \times 540$$

$$L = 2154 \text{ B.t.u.}$$

Assuming a heat value of 12,000 B.t.u. for the coal per pound as fired, then the percentage loss, L^1 , would be,—

$$L^1 = \frac{2154}{12000} \times 100$$

$$L^1 = 17.95 \text{ per cent.}$$

Other Losses:—In obtaining a heat balance as in boiler tests, other heat losses are taken account of. They include:

- A. The latent heat of vaporization of moisture.
 - B. The heat of the water vapor passing off at the temperature of the chimney.
 - C. The heat combustion of carbon to CO, instead of to CO₂.
 - D. The unburned carbon in the ash.
- A. The water from which the loss of heat is calculated is made up of
- (a) The total hydrogen of the coal burning to H₂O, that is $H \times 9$.
 - (b) The free moisture of the coal.
 - (c) The moisture of the air as indicated by the relative humidity.

The sum of the three amounts of water referred to the unit of 1 pound of coal multiplied by the factor for the latent heat of vaporization represents the heat loss in B.t.u. per pound of coal thus:

$$\left. \begin{array}{l} \text{B.t.u. loss} \\ \text{per pound} \\ \text{of coal} \end{array} \right\} = \text{Wt. of H}_2\text{O} \times 966$$

B. Having found the weight of water as under A, the heat loss due to rise in temperature from room temperature, t , to 212° , and from 212° to temperature of flue gases, T , is found, using the specific heat factor for the water vapor, of 0.467, thus:—

$$\left. \begin{array}{l} \text{B.t.u. loss} \\ \text{per pound} \\ \text{of coal} \end{array} \right\} = \text{H}_2\text{O} \times (212-t) + \text{H}_2\text{O} \times 0.467 \times (T-212)$$

C. The heat loss due to the burning of carbon to CO instead of CO_2 is found by multiplying the weight of carbon thus entering into the reaction per pound of coal, by the difference between the calorific value of carbon burned to CO_2 and carbon burned to CO, thus:—

$$\left. \begin{array}{l} \text{B.t.u. loss from CO} \\ \text{per pound} \\ \text{of coal} \end{array} \right\} = \text{Wt. C. in CO} \times 10150$$

D. The loss of heat due to combustible matter passing through with the ash unburned is found by determining the combustible in the ash as carbon, c , and referring it to the total refuse, r , in its proper proportion, x , to the ash, a , of the original fuel thus:

$$c : r :: x : a$$

Having the value, x , in percentage of the original coal as fired, then,—

$$\left. \begin{array}{l} \text{Heat loss per pound} \\ \text{of coal from unburned carbon} \end{array} \right\} = x \times 14550.$$

CHAPTER IV

LUBRICANTS.

“Next to the conservation of the world’s fuel supply there is probably no subject of greater importance in the manufacturing world than the control of waste power caused by imperfect lubrication and needless friction. * * * * Archbutt has stated that of the 10,000,000 h.p. in use in the United Kingdom of Great Britain considerably more than half this amount, 40 to 80 per cent of the fuel, is spent in overcoming fric-

tion, and that a considerable proportion of this power is wasted by imperfect or faulty lubrication.”*

Any substance made use of for the lessening of friction is called a lubricant. By its use the surfaces of sliding bodies are separated by a thin film which permits of easier movement than if the surfaces were in direct contact. Lubricants must, therefore, vary widely for the different kinds of work involved. For example, the “body” must be suited to the load. Working temperatures, both high and low, must be provided for. Oxidizing or gumming must not be a property of the material, and any tendency to corrode the metal surfaces must be absent.

Lubricants are derived from two main sources:

First, Oils of animal or vegetable origin

Second, Mineral oils.

Animal and Vegetable Oils:—All oils of this class are saponifiable. That is, they are compounds of fatty acids and glycerine. They decompose to a considerable extent on long standing, setting free the fatty acids. Many vegetable oils, as linseed oil, readily oxidize, forming a gumming substance. Only non-oxidizable oils are suitable for lubrication. Among vegetable oils the best known illustrations are olive (sweet) oil and castor oil. Among animal oils, lard oil is perhaps the most common.

Mineral Oils:—These oils are derived from petroleum by distillation. They will not saponify, having no combination of fatty acids, and they will not oxidize to form “gumming” compounds.

The compounding of oils is an attempt to render a certain oil more effective by mixing with another oil having slightly different properties. Thus, mineral oils may be said to be compounded with an animal oil to impart greater body or viscosity to the mixture; or, a vegetable oil with heavy body but too little fluidity, may be compounded with a mineral oil to improve its property in that direction. Mineral oils are often compounded with each other to produce certain desired properties. Greases are mixtures of heavy oil residues or vaseline-like substances with mineral soap, such as lime soap, to the extent of 30 to 40 per cent, thus giving a mixture of great body for heavy machinery, shafting, gears, etc. Finely pulverized mica or graphite is also similarly employed.

For high temperature service the problem becomes more difficult. An oil must be selected which will not volatilize at the high temperature employed. The principal tests in the examination of oils have for their purpose the development of these various properties;—for example, the viscosity and body as shown by the viscometer, and specific gravity, the flash point for high temperature use, acid or saponification number to

*C. F. Maberry, Jour. Ind. and Eng. Chem. II, 115. 1910.

show whether or not the oil is compounded with animal or vegetable material.

Methods for testing lubricating ores, therefore, include determinations for

- (a) Viscosity
- (b) Specific gravity
- (c) Flash and fire temperatures
- (d) Saponification number

Because of their low cost and the ease with which they may be varied to meet the different conditions as to load, speed and temperature, petroleum and the products which may be derived therefrom have come to predominate in the entire field of lubricants.

Hydrocarbons of the general type, C_nH_{2n+2} or the paraffin series are probably best suited for lubrication purposes. However, because of the development of processes for distilling, cracking, and mixing it would be impossible to prescribe a chemical composition to conform to any specific type of carbon compounds. Doubtless some forms are more unstable than others and as a rule, in service at high temperatures as with automobiles, there is a tendency toward decomposition which is almost always accompanied by the formation of free carbon. Promoters of petroleum lubricants, however, who claim their special oils are without any carbon in their composition, have more zeal than chemical sense.

PART II

LABORATORY PROCESSES

CHAPTER V

INTRODUCTORY

Normal Solutions:—If the reaction between one solution and another can be gauged exactly as to the “end point”, that is, if that point can be noted where an exact balance exists between the two reacting substances, we may make use of these solutions as media for making chemical measurements, just as a mechanic uses a foot rule for measuring lengths. Given, therefore, a solution of known value, that is, a standard solution, and a reaction where the end point or chemical equilibrium can be made visible to the eye by any means, we have a method which can be used to measure other solutions of unknown value. When a standard solution has its chemical value made up in terms of the molecular weight of the substance in grams per liter, it is called a ~~molar~~ molar solution. It is more convenient, however, to make up such solutions on the basis of the hydrogen equivalent of the part of the molecule concerned, in order to avoid the necessity of multiplying or dividing by two where ions of different valencies interact. Thus,

$2\text{HCl} + \text{Na}_2\text{CO}_3 = 2\text{NaCl} + \text{H}_2\text{CO}_3$ would call for two molecular quantities of HCl and one of Na_2CO_3 or one of HCl and $\frac{1}{2}$ of Na_2CO_3 . Again,

$\text{HCl} + \text{Na}_2\text{CO}_3 = \text{NaCl} + \text{NaHCO}_3$ would call for one full molecular quantity of HCl and $\frac{1}{2}$ of the molecular value for the Na_2CO_3 . By common agreement the single hydrogen equivalent has been adopted as the basis, and solutions of this kind are called *normal* solutions. Hence, a normal solution of the first substance, HCl, has exactly 36.46 grams per liter. A normal solution of the second has exactly 53.00 grams or $\frac{1}{2}$ of the molecular weight, 106.0, of sodium carbonate per liter. Where solutions of less strength are needed, tenth or hundredth

normal solutions are used, expressed thus:— $N/_{10}$ or $N/_{100}$. Thus, $N/_{10}$ sodium carbonate has 5.300 grams of the pure substance per liter and each c.c. contains .0053 gram of the alkali.

It is important that the full significance and value of the processes involving normal solutions be well understood at the outset of the work. The preliminary experiments following will help to this end.

PRELIMINARY EXPERIMENTS

EXERCISE I

Standard Sodium Carbonate:—The preparation of $N/_{10}$ sodium carbonate solution is carried out as follows:—

Clean and dry a porcelain crucible or small porcelain dish, then ignite it lightly and cool down to room temperature, putting into the desiccator at about 150° . Weigh accurately and add about six grams, more or less, of pure, dry sodium carbonate. Raise to a red heat, short of melting, and cool in a desiccator. Counterpoise upon the balance in such a manner that by removing with a clean knife blade or spatula the excess of material, there shall remain in the crucible exactly 5.300 grams of the carbonate. Empty the carbonate into a No. 3 beaker and add 50 or 100 c.c. of distilled water. Rinse out the crucible also a number of times, adding the washings to the beaker. After solution of the carbonate is complete, pour the contents of the beaker into a liter measuring flask. Rinse out the beaker thoroughly, transferring the washings to the flask and make up finally to the mark. The temperature of the water employed for making up to volume should not exceed 20°C . Stopper and mix by shaking until an absolute certainty of uniform distribution of the solution is attained. If the sodium carbonate is pure and the proper care in regard to transferring, mixing, temperature, etc., has been observed, we should now have a strictly $N/_{10}$ solution. To test its accuracy, obtain from the instructor some of the ready prepared $N/_{10}$ hydrochloric acid solution and proceed as follows.

Measure about 20 c.c. of the sodium carbonate from a burette into a clean beaker. Add about 20 c.c. of water and two drops of methyl orange solution. Titrate very slowly with $N/_{10}$ hydrochloric acid from a burette. Add acid drop by drop until the yellow turns to an orange color. More acid will make the solution pink, but this is too far—the intermediate orange tint denotes neutrality. More accurate results will be obtained if the solutions are titrated back and forth until one drop of either solution will change the color of the indicator. Repeat this titration three times and average the results. The quantity of acid required should not vary from the solution taken by more than 0.1 c.c. If there is a greater difference than this, the strength of the sodium carbonate solution may be calculated from the known hydro-

chloric acid solution. This correction is known as the $N/_{10}$ factor. The factor must be taken into consideration whenever the sodium carbonate solution is used. The exactly $N/_{10}$ solutions are much to be preferred where a large number of determinations are being made. What applies to the sodium carbonate solution is equally true with all standard solutions that are used. From the $N/_{10}$ sodium carbonate solution make a $N/_{50}$ sodium carbonate solution.

EXERCISE II

Standard Sulphuric Acid.—Prepare a $N/_{10}$ solution of sulphuric acid by means of the $N/_{10}$ Na_2CO_3 solution as follows:

Measure about $3\frac{1}{2}$ c.c. of pure concentrated sulphuric acid into a flask containing 1050 c.c. of distilled water. Mix thoroughly and fill a 50 c.c. burette with the solution. Measure 20 c.c. from the burette into a clean beaker, add about 20 c.c. of water and 2 drops of methyl orange. Titrate slowly with $N/_{10}$ sodium carbonate solution from a burette until the end reaction is shown by the first change of color from pink to orange. Repeat the titration as before, being careful to note the correct color for the end point. The acid solution is probably too strong. If the titration with $N/_{10}$ sodium carbonate requires, say, 21 c.c. instead of 20 c.c., then in such case 20 c.c. of acid would need to be diluted to 21 c.c. to make an exact balance to the alkali solution. Similarly 200 c.c. would need to be diluted to 210 c.c. and the dilution for any amount would be indicated by the proportion

$$20 : 21 :: 1000 : x$$

Hence, in the above example, measure an exact 1000 c.c. of the trial acid and add 50 c.c. of pure water to it. Test the accuracy of the resulting solution with $N/_{10}$ sodium carbonate as before.

EXERCISE III

Determination of Sulphur.—(Consult also the description for the determination of sulphur under Proximate Analysis of Coal, p. 103.)

Measure out 10 c.c. of the $N/_{10}$ sulphuric acid solution and make up to 100 c.c. Measure carefully 10 c.c. of this solution into a 100 c.c. cylinder and fill two-thirds full of water. Add 5 drops of pure concentrated hydrochloric acid, make up to the 100 mark, pour into an Erlenmeyer flask and add about 0.2 to 0.4 gram of special Barium Chloride powder ($\text{BaCl}_2 + \text{H}_2\text{C}_2\text{O}_4$) and shake thoroughly. Warm slightly to prevent the crystallization of the oxalate salt. Let stand for 15—20 minutes with occasional shaking. Take the solution to the photometer room.

Light the gas, adjusting to such a height that the tip of the flame just appears above the edge of the metal chimney.* Turn out all the lights in the room. Arrange the apparatus so that looking down the graduated tube the flame is seen as a small bright point *in the center* of the bottom of the tube. Now run in the solution, with barium sulphate in suspension, until the point of illumination just disappears from sight. Read off the height on the graduated tube, and repeat twice. If the column is less than 60 or more than 160 m.m. in depth, reject the test and start anew using double or half the quantity of solution under test, making up to 100 c.c. in each case as before.

On page 107 will be found a curve on which is indicated the number of grams of sulphur per 100 c.c. of solution corresponding to the various heights. Calculate the weight of sulphur indicated to sulphuric acid. Note that the actual amount of the $N/_{10}$ solution taken for the test is 1 c.c.

One cubic centimeter of $N/_{10}$ sulphuric acid has what weight of acid present?

How much sulphur?

What would be the equivalent amount of hydrochloric acid? Sodium Carbonate? Calcium carbonate?

EXERCISE IV

Standard Calcium Chloride and Soap Solutions:—Measure from a burette into a clean No. 2 beaker 40 c.c. of $N/_{10}$ hydrochloric acid. What equivalent does it contain in terms of sodium carbonate? What equivalent in terms of calcium carbonate? Weigh carefully 0.210 gram of pure calcium carbonate powder and add it to the 40 c.c. of $N/_{10}$ hydrochloric acid. Cover with a watch glass and heat for a few minutes till all action has ceased. Transfer to a liter flask. Wash out the beaker thoroughly with distilled water, transferring the washings to the flask. Make up to the mark and mix thoroughly by shaking. Allow the contents to stand quietly until all undissolved material has settled to the bottom. Siphon off half or more of the clear solution into a suitable flask and label "STANDARD CALCIUM CHLORIDE SOLUTION". Since one c.c. of a $N/_{10}$ solution is equivalent to one c.c. of any other $N/_{10}$ solution, we have in the above solution 40 c.c. of a $N/_{10}$ CaCl_2 solution. Although calcium carbonate is not soluble in water, the 40 c.c. of $N/_{10}$ calcium chloride is equivalent to the amount of calcium carbonate in 40 c.c. of a theoretical $N/_{10}$ solution of calcium carbonate. Since in one c.c. of a

*A tungsten lamp is to be preferred where available. It should be 3 to 4 volt, such as may be obtained from 2 dry cells with the bulb of clear glass without flaw.

$N/_{10}$ solution of calcium carbonate there are .005 grams of calcium carbonate, in the 40 c.c. of hydrochloric acid solution or the liter of solution there are .2 grams of calcium carbonate. The standard calcium chloride solution, therefore, has a value of 200 parts per million in terms of calcium carbonate.

The standard soap solution is obtained from the stock shelf. It is prepared by dissolving 10 grams of castile soap in 100 c.c. of 80 per cent alcohol. After standing for several days it is further diluted with 70 per cent alcohol to a point where 5 or 6 c.c. of it as measured from a burette will produce a permanent lather when added as directed below to 20 c.c. of the standard calcium chloride solution. This will require usually a dilution up to 900 or 1000 c.c.

Standardization of the Soap Solution:—Measure 20 c.c. of the standard calcium chloride solution into a 250 c.c. glass stoppered bottle and add 30 c.c. of distilled water. Run in from a burette the standard soap solution 0.4 or 0.5 c.c. at a time, shaking the bottle vigorously after each addition. Lay the bottle on its side after each shaking and note if the lather remains. The end point is taken where the lather remains over the entire surface of the water for five minutes after shaking. Make three tests of the standard calcium chloride solution as above prepared. Repeat the process, using 10 c.c. of the calcium chloride solution and making up to the same volume (addition of 40 c.c. water) as before. By thus establishing a number of points as for 10, 15, 20 and 25 c.c., in which the required soap solution has been determined, a curve for the strength of the soap solution is developed as illustrated in the chart, Fig. 14.

The hardness of a water is due to any mineral constituents in solution other than compounds of sodium, potassium, ammonium, etc., members of the first or soluble group. Upon the addition of soap to a hard water there are formed insoluble soaps of calcium, magnesium and iron, which are precipitated in curdy granules. When all of these constituents are precipitated the water is soft. It is this action of soap which permits of its use in a standard solution for measuring the total hardness.

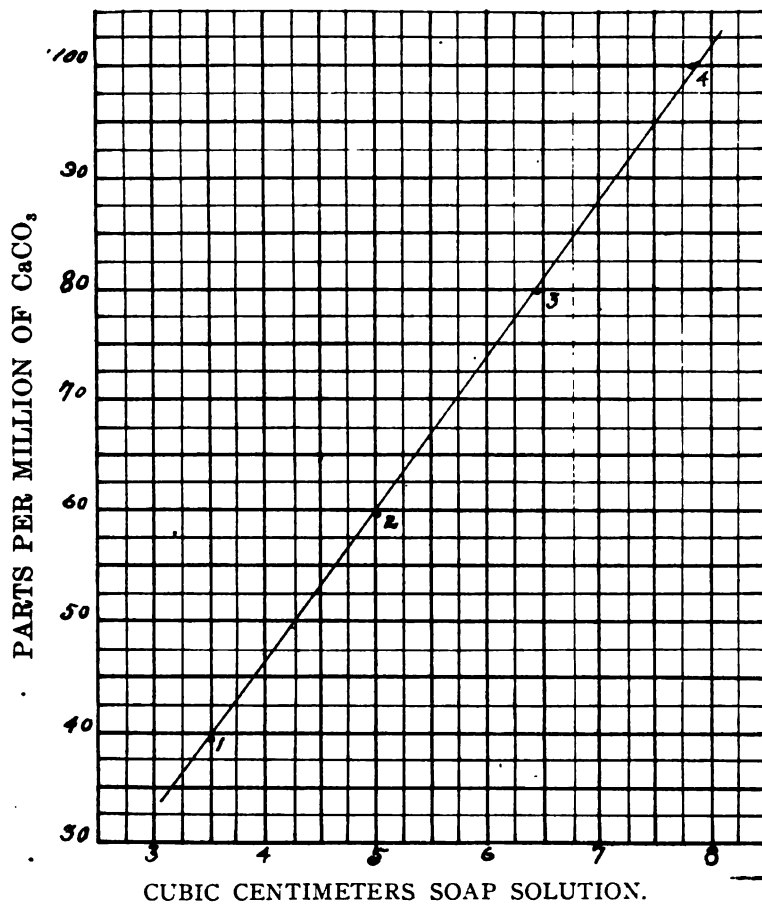

Fig. 14. Development of the curve for a standard soap solution, with the points located as follows:—

Point No. 1, using 10 c.c. CaCl₂ sol.

Point No. 2, using 15 c.c. CaCl₂ sol.

Point No. 3, using 20 c.c. CaCl₂ sol.

Point No. 4, using 25 c.c. CaCl₂ sol.

EXERCISE V

Determination of Calcium Sulphate in Water:—Get a bottle of unknown "A" for analysis. Add 25 c.c. to a clean beaker with a pipette, then run in 10 c.c. of $N/_{10}$ sodium carbonate solution. Boil for 5 minutes on a sand bath, then filter into a clean beaker. Wash well with hot water, saving all the washings until the liquid leaving the funnel is neutral to litmus paper. Now add 2 drops of methyl orange to the filtrate and washings and titrate with $N/_{10}$ hydrochloric acid.

The equation representing the reaction between sodium carbonate and calcium sulphate is

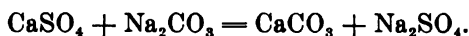

Since the titrated sodium carbonate is the balance of the 10 c.c. remaining unchanged after the reaction has taken place, the difference between this amount and the 10 c.c. originally added represents the amount of sodium carbonate taking part in the reaction, and from this, remembering always the equivalent of normal solutions, compute the weight of calcium sulphate present. Since a 25 c.c. sample was taken, how many *grams per liter* did the solution contain? How many parts per million? How many grains per U. S. Gallon?*

Calculate also the lime, in grains per gallon, equivalent to the calcium sulphate present. Calculate also the equivalent of calcium carbonate in grains per gallon corresponding to the sulphate ion present. From the amount of hydrochloric acid used, calculate the sodium chloride (NaCl) formed.

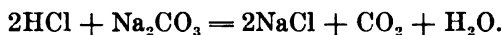

Perform all these calculations in the note book for inspection and reference.

CHAPTER VI

BOILER WATER ANALYSIS

EXERCISE I

Excess or Free Carbon Dioxide:—By this is meant the carbon dioxide held in solution by the water. It is not scale forming material, but in water treatment it behaves as so much temporary hardness, and the amount present must be determined in order to gauge correctly the quantity of reagent required in the treatment. The "excess" carbon dioxide is readily taken up by calcium hydroxide, $\text{Ca}(\text{OH})_2$, forming

*Milligrams per liter or parts per million $\times .0583 =$ grains per U. S. gallon.
See p. 24.

calcium carbonate; or by sodium carbonate, forming sodium bicarbonate. So long as there is present free carbon dioxide, it acts toward phenolphthalein as acid, decolorizing the same. The first excess of Na_2CO_3 beyond the point of absorption of the CO_2 is denoted by a pink coloration of the indicator.

Procedure.—With the graduated cylinder measure 200 c.c. of the water into a No. 3 (350 c.c.) beaker. Add a few drops of phenolphthalein as indicator and titrate to the end point with $\text{N}/_{50}$ sodium carbonate free from bicarbonate. The number of c.c. used times 5 represents the equivalent or excess of CO_2 in parts per million, but measured in terms of calcium carbonate.

EXERCISE II

Total Alkalinity and Temporary Hardness:—Temporary hardness is due to the calcium, magnesium, and iron held in solution in the form of bicarbonates. They are readily broken down by dilute acids and, until so destroyed, are alkaline towards methyl orange indicator.

Procedure.—Measure 200 c.c. of the water into a No. 3 beaker, add a few drops of methyl orange and titrate with $\text{N}/_{10}$ sulphuric acid. From the number of c.c. used can be calculated the equivalent in parts per million of temporary hardness measured in terms of calcium carbonate. Note that to calculate the value in c.c. per liter we would need to multiply the titration by five. The equivalent value for $\text{N}/_{10}$ sulphuric acid in terms of calcium carbonate is 0.005 gram per c.c. of solution. Hence, five times the number of c.c. per liter would represent the calcium carbonate in milligrams per liter. That is, 25 times the titration number represents milligrams per liter or parts per million of calcium carbonate equivalent.

Note:—If under Exercise V below sodium carbonate is found to be present as negative hardness, the temporary hardness is equal to the total alkalinity minus the negative hardness. If there is no negative hardness the temporary hardness is equal to the total alkalinity.

EXERCISE III

Magnesia:—Use the solution from Exercise II above. Cover the beaker with a watch glass, boil for fifteen minutes, add 50 c.c. of saturated lime water and allow to stand at near the boiling temperature for about fifteen minutes. Filter into a 250 c.c. flask, wash with boiled distilled water and add water so that the volume at room temperature will be 250 c.c. Titrate 100 c.c. with $\text{N}/_{10}$ sulphuric acid, using the methyl orange indicator. Make at the same time the same determination, using pure distilled water in place of the water analyzed. The

difference between the two titrations is the amount of sulphuric acid which would have been neutralized by the calcium hydroxide, which has precipitated the magnesium from the water. Since the amount titrated, 100 c.c., is equal to $\frac{2}{5}$ of the 250 c.c., it must also be equal to $\frac{2}{5}$ of the original 200 c.c. Then the difference between the titrations multiplied by $(\frac{5}{2 \times 5 \times 5})$ equals the equivalent in parts per million of the magnesia in the water measured in terms of calcium carbonate.

Note:—Because of the solubility of magnesium carbonate in the presence of alkali bicarbonates, it is necessary to precipitate the magnesium as hydroxide. In water treatment, therefore, the magnesium bicarbonate requires double the amount necessary to simply bring it to the carbonate stage. (See p. 16, Part I).

EXERCISE IV

Permanent Hardness:—Boil in a porcelain dish 500 c.c. of the water for about 10 minutes and add 25 c.c. of $N_{/10}$ "soda reagent" (equal parts of sodium hydroxide and sodium carbonate) and boil further to about $\frac{1}{2}$ volume. Filter, wash and make up to 250 c.c. Titrate 100 c.c. of this solution with $N_{/10}$ sulphuric acid, using methyl orange as an indicator. The amount of original water used is then 200 c.c. since the 100 c.c. used is $\frac{2}{5}$ of the 250 c.c. and consequently $\frac{2}{5}$ of the 500 c.c. The difference between this titration and the amount of acid equivalent to ~~25~~ 10 c.c. $N_{/10}$ soda reagent multiplied by (5×5) represents the equivalent of permanent hardness in parts per million measured in terms of calcium carbonate. Calculate also the amount in parts per million of the sodium sulphate formed by the reaction and refer the result for use under exercise number IX.

In the reaction, as with "soda reagent" for example

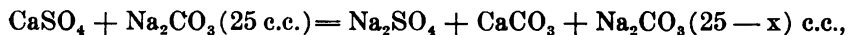

it is seen that part of the $N_{/10}$ sodium carbonate has changed over to sodium sulphate. The extent of this change is dependent, of course, upon the quantity of calcium sulphate, magnesium sulphate, etc., present in the water and the measure of the change is indicated by the titration of the filtrate. It is to be noted again that in so far as magnesium sulphate may be present, the magnesium carbonate formed is soluble to a considerable extent, hence the more insoluble magnesium hydroxide is provided for by the use of the "soda reagent", which is part sodium hydroxide.

Some waters will give a titration in the filtrate which is greater in amount than the quantity of soda reagent added. This condition is designated as negative hardness.

EXERCISE V

Negative Hardness:—Throughout this region a very large percentage, especially of the deep wells, yield waters of Class I, as described on page 11. Such waters have no sulphates of calcium or magnesium present. They have, however, some free sodium bicarbonate instead, which indicates that some such reaction as indicated in Exercise IV above has taken place while the water was percolating through the ground. The treatment, therefore, prescribed above would result simply in the addition of more alkali. Hence, the excess of acid required over the 10 c.c. of alkali added would be a measure of the free sodium carbonate or "negative hardness" present. Multiplying by (5x5.3) would give the weight in milligrams per liter of Na_2CO_3 . Calculate the negative hardness in terms of calcium carbonate in order to obtain the temporary hardness. Determine the amount of negative hardness in the laboratory tap water.

EXERCISE VI

Total Hardness:—The total hardness of a water may be derived (a) from the data which has resulted from experiments II and IV above, and (b) from the soap test. It is well to use both sources of information as a check.

(a) Under experiment II there will be measured the amount of temporary or bicarbonate hardness, that is, the amount of calcium, magnesium and iron present as bicarbonates, but measured all together in terms of calcium carbonate by the titration with $\text{N}/_{10}$ hydrochloric acid or sulphuric acid.

Under experiment IV there will be indicated the amount of sulphate or chloride hardness; that is, the amount of calcium, magnesium or iron which may be present in the form of the sulphates or chlorides of these elements, but measured again in the equivalent of calcium carbonate. Be sure that experiment No. V has been taken into this account, for, if free sodium bicarbonate is present, there will be no permanent but only temporary hardness to enter into the total hardness. The sum of the temporary hardness and permanent hardness, (if any), given in terms of calcium carbonate, represents the total hardness.

(b) Make a determination of total hardness by means of the standard soap solution as follows:—

Measure 50 c.c. of the water into a No. 3 beaker, add a few drops of methyl orange and titrate with $\text{N}/_{10}$ sulphuric acid to the end point. Transfer the water thus neutralized to the shaking bottle used for the soap test and run in from a burette, the standard soap solution, a few tenths of a cubic centimeter at a time, shaking vigorously after each addition. The end point is taken in the same manner by noting where,

upon laying the bottle on its side after shaking, the lather remains for five minutes. With waters containing magnesium salts care must be taken to avoid mistaking the salts of magnesium end point. After the titration is apparently finished read the burette and add 5 c.c. of soap solution. If the end point was due to magnesium the lather disappears. Continue the addition of soap solution until the true end point is reached.

Upon the page of dimension paper herewith, locate a curve which represents the strength of the soap solution used and from this read the

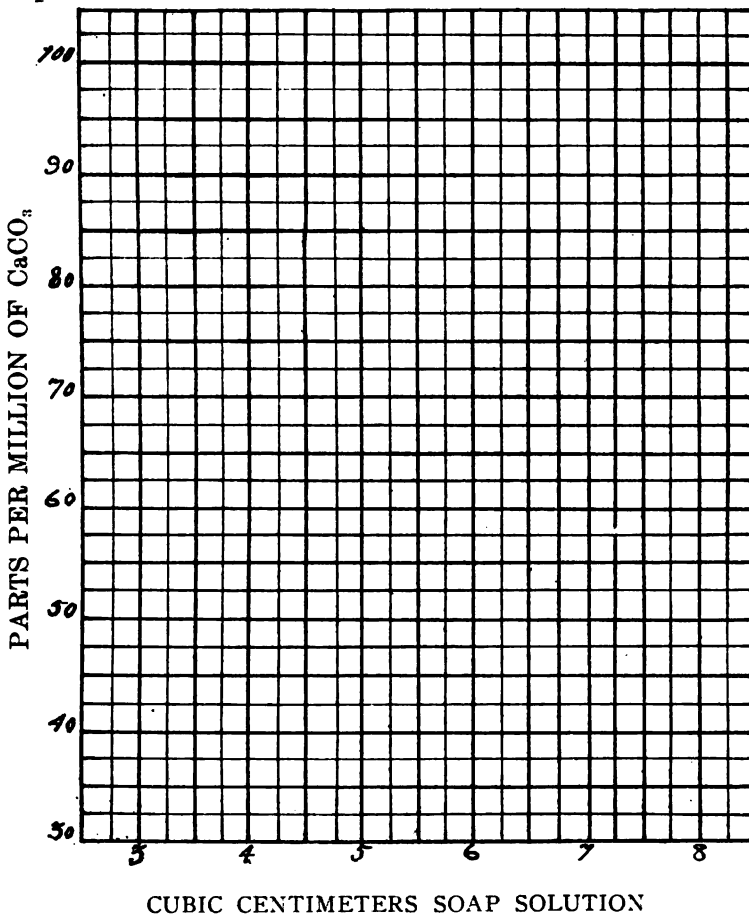
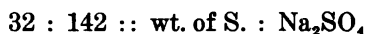

FIG. 15. PLOTTING A CURVE FOR STANDARD SOAP SOLUTION
Showing the value in parts per million of CaCO₃.

amount of parts per million in terms of calcium carbonate. How does the amount compare with the total hardness as derived under (a) above?

EXERCISE VII

Determination of Total Sulphates.—Into a 100 c.c. cylinder measure 50 c.c. of water and add 2 or 3 drops of concentrated hydrochloric acid. Make up to exactly 100 c.c. in the graduated cylinder. Pour into an Erlenmeyer flask of about 200 c.c. capacity and add Special Barium Chloride as in Exercise II of Section II for the determination of sulphuric acid. Warm slightly. After standing 15-20 minutes, read in the photometer as directed in Preliminary Exercise III of Chapter II. Refer to the chart on page 107 for the weight of sulphur indicated by the photometer reading. Calculate to sulphuric acid thus



EXERCISE VIII

Determination of Total Chlorides.—Measure accurately 50 c.c. of water by means of a 50 c.c. pipette into a porcelain dish. Add about 1 c.c. of potassium chromate solution and titrate with $N/_{100}$ silver nitrate solution, until the yellow color gives place to the first permanent trace of reddish brown, do not wait for a red tint to appear. Fill another porcelain dish with 50 c.c. of distilled water and add 1 c.c. of the indicator. Use this as a standard of comparison. The first tinge of brownish red that can be distinguished in the titrated solution is to be taken as the end point.

The reactions involved are—



The silver chromate is a red precipitate, but as long as there is any soluble chloride in solution, this breaks up the chromate as follows—

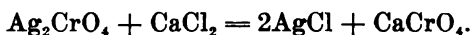

Thus, the first tinge of pink shows that the chlorine of the chloride has all been precipitated. From the volume of silver nitrate used to this point, calculate the weight of chlorine in the 50 c.c. taken thus

$$\text{Vol. } N/_{100} \text{ AgNO}_3 \times .0003545 = \text{wt. Cl. in 50 c.c.}$$

and $0.0005845 \times$ the vol. $N/_{100} \text{ AgNO}_3 = \text{wt. NaCl in 50 c.c. of the water.}$ Multiplying further by 20 will give the weight per liter. From this is indicated, by referring to milligrams, the milligrams per liter or parts per million.

EXERCISE IX

Total Alkalies.—The total alkalies are considered as being made up of all the sulphate not combined as permanent hardness and all of the chlorides. It is true that small amounts of other alkali salts, as sodium nitrate, are present and occasionally some of the chloride is present as magnesium or calcium chloride; but, for the scope of this work and for ordinary technical requirements, it is quite sufficient to consider the total alkalies as being constituted as above indicated.

Procedure:—From the total sulphate as determined under No. VII and calculated to sodium sulphate, subtract the sulphate hardness as found under No. IV and which was there calculated also to the equivalent of sodium sulphate for this purpose. The remainder is the amount of alkalies existing in the water in the form of sodium sulphate. To the above should be added the total chloride results under No. VIII, calculated to sodium chloride.

If free sodium carbonate or negative hardness was developed under No. V then this also in the form of equivalent sodium carbonate should be added as a third constituent of the alkalies.

The sum of these various constituents, referred in each instance to parts per million, is to be taken as the total alkalies in parts per million. Calculate this sum also to grains per U. S. Gallon.

EXERCISE X

Examination of a Treated Water.—1. If the water has been under treated, it is possible to determine *as with an untreated water* the amounts of lime and soda still needed to soften water.

2. In case excess of soda ash has been added, the permanent hardness will be *negative*; and, if the water has no sodium carbonate present originally, 1.06 times the negative hardness expressed as parts per million of calcium carbonate represent the excess of sodium carbonate which has been added to the water.

3. In most cases, however, a treated water is alkaline to phenolphthalein, in which case 200 c.c. is titrated with $N/10$ sulphuric acid, to the end point with phenolphthalein and then on to the end point with methyl orange.

If the amount of acid needed to give the end point with the phenolphthalein is more than half that which is needed to give the end point with methyl orange, an excess of lime is present. If the difference between the two quantities be subtracted from the number of c.c. for the phenolphthalein end point, the result shows the calcium carbonate equivalent in parts per million of the excess of pure lime, CaO. This equivalent multiplied by 56 gives the parts per million of CaO and this result multiplied by .0583 gives the amount in pounds per 1000 gallons.

EXERCISE XI

Summary of results and calculations:—The character of a water is shown by assembling in tabular form the various ingredients grouped in a manner to indicate the total scale-forming and the total foaming ingredients, as called for in the accompanying outline. This summary calls for the various results in grains per gallon, and the order and grouping is that of the exercises I to X.

The calculations for the requisite amount of reagents to remove the scaling ingredients involve simply the calculation from the determined equivalent of calcium carbonate over to the proper reacting substance, thus—

Since one equivalent of excess CO_2 , one equivalent of temporary hardness or one equivalent of magnesium requires one equivalent of calcium oxide for its removal from the water, 0.56 times the sum of the calcium carbonate equivalent of excess carbon dioxide, temporary hardness, and magnesium represents the number of parts per million of pure lime CaO , necessary to remove these difficulties.

1.06 times the calcium carbonate equivalent of the permanent hardness is the number of parts per million of sodium carbonate, Na_2CO_3 , necessary to remove the permanent hardness. 0.0583 times the quantities in parts per million gives the pounds per thousand gallons needed. The results above are for pure lime and sodium carbonate. Commercial lime and soda ash must be analyzed to determine the amounts of pure lime and sodium carbonate which they contain.

Note:—As an aid to calculations and a correct designation of the kind of alkalinity present the following table will be found helpful:

Letting *P t* stand for the titration when using *phenolphthalein* and *M o* for the titration when using *methyl-orange*, then,—

When $P t = M o$there are present hydroxides only.

“ $P t < M o > \frac{1}{2} M o$ “ “ hydroxides and normal carbonates.

“ $P t = \frac{1}{2} M o$ “ “ “ normal carbonates only.

“ $P t < \frac{1}{2} M o$ “ “ “ normal carbonates and acid carbonates.

“ $P t = M o$ “ “ “ acid carbonates only.

UNIVERSITY OF ILLINOIS
DEPARTMENT OF APPLIED CHEMISTRY

Analysis of Boiler Water from.....

No.....

Sample Taken..... 191.....

			Requiring for treatment of 1000 gallons	
	Parts per million	Grains per gallon	Gallons of saturated CaO Sol.	lbs. of 99.0 % Soda Ash
Free CO ₂ as CaCO ₃ Equiv.....				
Total Alkalinity as CaCO ₃ Equiv.				
Temporary hardness as CaCO ₃ Equiv.				
Negative hardness as CaCO ₃ Equiv.				
Magnesium as CaCO ₃ Equiv.				
Permanent hardness as CaCO ₃ Equiv.				
Total scale forming material.....				
Alkalies as Na ₂ SO ₄				
Alkalies as NaCl				
Alkalies as Na ₂ CO ₃				

Remarks

.....

.....

By.....

CHAPTER VII

THE PROXIMATE ANALYSIS OF COAL.

Introduction:—The procedure as here outlined for the proximate analysis of coal follows substantially the final report on methods of analysis as adopted by the joint committee of the American Chemical Society and the American Society for Testing Materials. The preliminary report of this committee published in the Journal of Industrial and Engineering Chemistry for June 13, Vol. 5, p. 17, contains much detail of value relating to sources of error and general conditions to be observed in the procuring of accurate results. The final report is in a much more condensed form and is intended as a guide for every-day procedure in connection with coal contracts, and inspection. This was printed as the report of Committee E-4 and presented at the annual meeting of the American Society for Testing Materials, June, 1915.

EXERCISE I.

Moisture Loss on Air Drying:—The sample as prepared for the laboratory should be four or five pounds in amount and transmitted in an air tight container. If the directions for sampling with regard to the fineness of division have been observed the laboratory sample will be approximately 4-mesh or $\frac{1}{4}$ inch in the diameter of the largest particles.

Spread the sample on a tared pan about 18" x 18" x $1\frac{1}{2}$ " in depth. Weigh and air dry at room temperature or in a special drying oven through which a current of air is circulated and in which the temperature is maintained at 15° to 25° Fah. above that of the room. Weigh again after twelve hours. The moisture content should now be in approximate equilibrium with the moisture of the air. This will mean a moisture factor of from 3 to 5 per cent. It may be indicated by the fact that a continuation of the drying process will not show a loss of more than 0.1 per cent per hour. Note the loss of moisture on air-drying and calculate to per cent of the entire sample.

Working Sample:—Pass the air dried sample entire at once after final weighing, through a grinder of the coffee mill type set to grind to about 20 mesh. Immediately after passing through the grinder, spread out on a tray and with a spoon take from various parts a 60 gram sample and place directly in a rubber-stoppered bottle and label "For Total Moisture".

Thoroughly mix the main portion of the sample, reduce by means of a riffle to about 60 grams. Pulverize to 60 mesh on the bucking board, passing all of the material through the sieve. Transfer to a four-ounce rubber stoppered bottle and label "Laboratory Sample for Coal Analysis".

EXERCISE II.

Total Moisture:—In a dry glass capsule with ground glass cover weigh out 5 grams of the 20-mesh sample labeled "For Total Moisture". Heat with the cover off for $1\frac{1}{2}$ hours in an oven maintained at 104° to 110° C. Cool in a desiccator over concentrated sulphuric acid, sp, gr. 184. Weigh. Calculate the moisture thus found to the percentage it would be of the original coal before air drying and add to the air-drying loss, thus,—subtract the percentage loss on air-drying from 100 and multiply by the oven drying loss to find the percentage to be added, or as a formula:—

$$\frac{(100-a) \times a^1}{100} + a = \text{total moisture "as received"},$$

in which (a) is the moisture loss on air-drying and (a^1) is the loss on drying the air-dry sample at 104° — 110° C.

Moisture in the Laboratory Sample:—Determine the moisture on the 60-mesh laboratory sample, by weighing out 1 gram in a glass capsule as in Exercise II and drying with the cover off at 104° — 110° C. for one hour. Replace the cover, cool in the desiccator and weigh. The loss of weight is the amount of water in the sample. Save for ash determination.

EXERCISE III.

Ash:—Transfer the 1 gram of coal remaining in the glass capsule from the moisture determination to a porcelain crucible. Place on a triangle 2 or 3 inches above the tip of a flame which has been turned down to about 2 inches in height. It can be left in this condition without attention for 15 or 20 minutes, when most of the carbonaceous matter will have been burned off. Lower the crucible to within $\frac{1}{4}$ or $\frac{1}{2}$ inch of the flame and leave without attention for an equal length of time. Occasional stirring with a platinum wire will facilitate the oxidation. Finally place the crucible on the triangle in an inclined position so as to facilitate the circulation of air currents over the ash; apply the blast flame to the bottom of the crucible for 5 to 10 minutes or until the ash does not lose in weight upon further blasting. Cool in the desiccator and weigh. Subtract the weight of the crucible and compute the weight of the ash to percentage of air dry coal.

EXERCISE IV.

Volatile Matter, Official Method:—The standard method for determining the volatile matter in coal as indicated by the joint committee on coal analysis in the Journal of Industrial and Engineering Chemistry, June, 1913, prescribes the use of a platinum crucible with capsule

cover fitting inside of the crucible;—that is, telescoping $\frac{1}{8}$ to $\frac{1}{4}$ of an inch, instead of an ordinary cover resting on the upper edge. The crucible with 1 gram of coal is placed in a muffle maintained at 950° C. ($\pm 20^{\circ}$ C.) A vertical electrically heated muffle is easy of construction and greatly to be preferred for this work. On account of the variation in pressure and heating value of city gas it is practically impossible to obtain consistent results with the Bunsen or Méker burners. A muffle heated by gas and maintained at the proper temperature is much to be preferred to heating by the direct flame.

On account of the expense of platinum the use of a porcelain crucible is necessary in class work as indicated below. It is to be noted that any method which retards the transmission of heat to the coal will result in a lower indicated amount for volatile matter, and a correspondingly higher percentage for fixed carbon. To overcome this discrepancy, therefore, the porcelain crucible is put directly into a highly heated chamber and the heat applied from the first at or above the prescribed temperature. In this manner the results should check the official method within 0.5 per cent. The volatile matter values will be found consistently lower than percentages obtained by the official method by about that amount.

Porcelain Crucible Method:—Select a porcelain crucible with well fitting cover, ignite, with cover, in the flame of a Bunsen burner to a dull red heat, cool in the desiccator and weigh. Place a nichrome triangle over a blast lamp and over the triangle place an inverted 20 gram assay crucible with the bottom ground off, exposing a hole approximately one inch in diameter. When this apparatus is heated to as high a temperature as possible, remove the inverted crucible, put in place the porcelain crucible with cover on containing one gram of air-dry coal. Continue the heating for seven minutes and at the end of this period turn off the flame and remove the assay crucible but do not disturb the cover of the porcelain crucible until the same has been reduced below a red heat. Transfer to a desiccator, cool and weigh with the cover. The loss in weight minus the moisture present is the weight of volatile matter.

EXERCISE V.

Fixed Carbon:—The sum of the percentages for moisture, (on the air dry or working sample) ash, and volatile matter, subtracted from 100, will leave as a remainder the percent of fixed carbon in the air dry coal.

Calculations:—Calculate each value for the air dry sample to percentages of dry (moisture free) coal by dividing each by 1.00—the weight found for that constituent.

Calculate to the “as received” basis by multiplying each factor as derived for the dry coal by 1—the total moisture factor.

EXERCISE VI.

Calorific Value.—If the amount of moisture in the air-dried coal is less than two per cent, no drying in the oven is necessary for the determination of calorific value. One-half gram of air-dried coal is used and the detailed directions should be followed as given below.

General Arrangement.—The Calorimeter should be placed on a good, firm desk in a room where the fluctuations of temperature may be avoided. The general arrangement of parts is shown in Fig. 16. How-

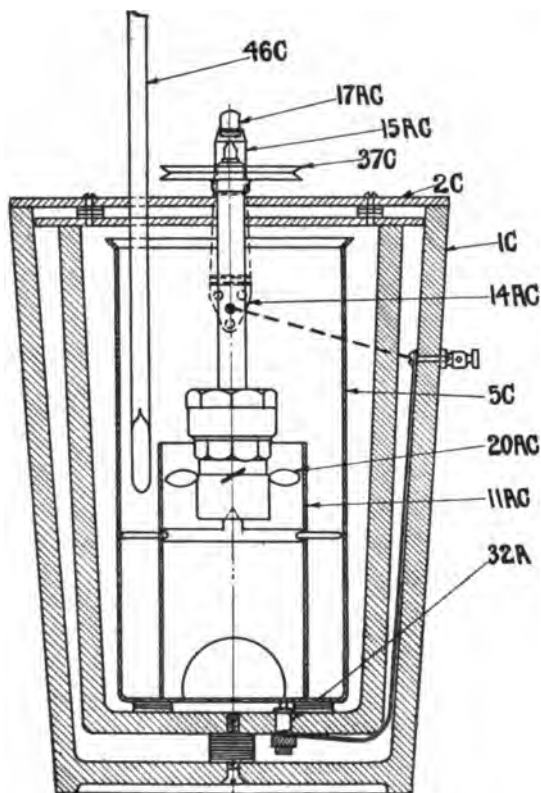

Fig. 16
Calorimeter Using Sodium Peroxide

ever, it is better to remove the can 5C from the instrument for filling with water. The outside of the can should be dry, and no water should be allowed to spill over into the air spaces of the insulating vessels.

Exactly two liters of water (preferably distilled) are used, and it should have a temperature of 2 or 3 degrees F. below that of the room.

The thermometer 46C should extend a little over half way to the bottom of the can. The pulley 37C is connected by a light, flexible cord with a small electric or water motor. Stirring is effected by the spring clips with turbine wings 20AC placed on the bell body. The pulley 37C must be made to revolve at a rather brisk rate. About 150 revolutions per minute, uniformly maintained, will insure a complete equalization of temperature throughout the water. The pulley should turn to the right or as the hands of a watch.

The Chemical: Sodium Peroxide Na_2O_2 .—It is absolutely necessary that the chemical employed (sodium peroxide) be kept free from contamination. It has special avidity for moisture, and the glass jar with lever fastener, as shown in Fig. 17, has been found best adapted as a container for this material. The sodium peroxide is furnished in small sealed tins, and the entire contents of a can, upon opening, should be transferred completely to the jar. The half-pound tins will usually be found the most convenient size to use. In any event, the glass jar should be of sufficient size to permit of the complete emptying of the container.

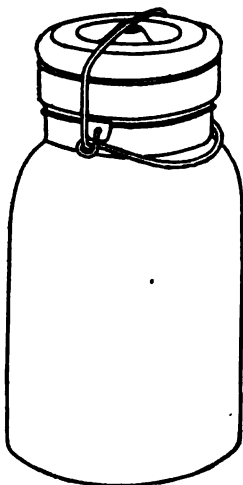

Fig. 17

Container for Sodium Peroxide.

Commercial sodium peroxide or material that has been much exposed to the air so that any considerable amount of moisture has been absorbed, will give variable and uncertain results.

The Accelerator: Potassium Chlorate, $KClO_3$.—In order to secure a combustion that shall be uniformly complete, it has been found desirable to use an accelerator for the purpose of increasing or intensifying the oxidizing effect of the sodium peroxide. While numerous chemicals

and mixtures have been tried, a very extended experience has made it evident that potassium chlorate is best adapted for this purpose. The amount needed for each charge is weighed out in the same manner as for coal. One gram is the weight taken for fuel of all types.

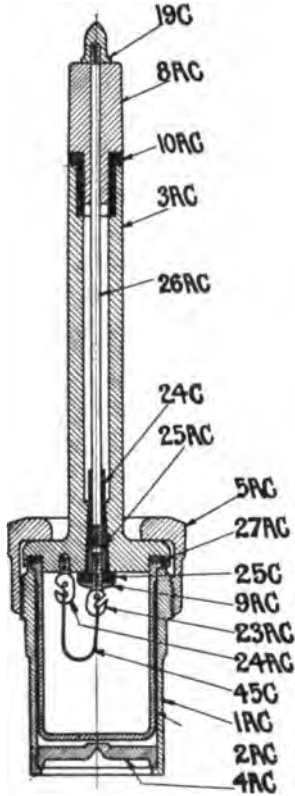

Fig. 18

Peroxide Bomb.

gram of oven-dry coal. Replace the false top and shake again. When the mixing is complete, tap the holder lightly on the desk to shake all of the material from the upper part of the container, remove the false cap and put in its place the regular cap with stem and ignition wire 3AC. To attach the ignition wire, take a single length of fuse wire 7cm. long from the card; pass one end through the eyelet of one of the terminals, 24AC, so it will extend beyond the eyelet, say $\frac{1}{4}$ ". Wrap the free wire around the terminal at the narrow portion formed by the notch, giving it three turns, binding in the free end and bending the wire finally downward in line with the terminal. Repeat the same process with the other end of the wire in the other terminal 23AC. Do not

Making Up the Charge:—See that the floating bottom 4AC is in place at the lower end of the bell body as shown in Fig. 18. The inner surfaces should be dry so that the fusion cup, when put in place, will be surrounded by an air space with no film of water present. The fusion cup also should be *thoroughly dry* inside before adding the charge. It is well to dry it over a radiator or hot plate, though it should, of course, be cooled for filling. Add to the fusion cup, not assembled, one full measure of sodium peroxide. In filling the measure with peroxide, it should be tapped against the side of the glass jar to insure against the formation of air pockets which might prevent the complete filling of the measure. The same precaution also as to the dryness of the measure should be observed as for the fusion cup. It should be rinsed thoroughly with tap water after each using and dried by heating over a radiator or hot plate. Add one gram of accelerator immediately after adding the sodium peroxide. If the accelerator is lumpy, it is well to rub it smooth in a glass or agate mortar before weighing. Close with the false top 36C, Fig 19, and shake *thoroughly* until the ingredients are evenly mixed. Add now $\frac{1}{2}$

have the fuse loop too long. It is better not to extend too far into the charge. It will be noticed that the charge fills the crucible at least two-thirds full; hence, $\frac{1}{2}$ " extension of the fuse wire below the central terminal will be ample.

See that the rubber gasket 27AC is in good shape and that the stem cap seats itself properly. It is to be noted that the gasket seals both the upper edge of the crucible and also the upper edge of the bell body. Marring the edges or rims of any of these parts, therefore, must be carefully avoided. Screw down the cap 5AC firmly in place by use of the two wrenches; put on the spring clips with the stirring vanes downward, leaving the small holes near the lower edge of the bell body uncovered and assemble, as shown in Fig. 16. In assembling, bring the can to its proper place and add 2 liters of distilled water having a temperature 2° or 3° F. below that of the room. In placing the bomb in the water hold it in an inclined position in such a manner that the lower edge of the bell-body will enter the water at an angle and thus avoid entrapping an air pocket under the bottom.

Ignition:—The current required for igniting the charge should be from two to four amperes, and is readily obtained by placing in parallel five 16-candle power lamps in an ordinary lighting circuit of 110 volts. It is well to have the fifth lamp of 32-candle power. By this means a suitable current is readily obtained.

Make a number of preliminary tests by fastening a loop to the terminals and passing the current without assembling the parts. In this way the behavior of the fuse can be observed. Make a trial with three or four lamps in the circuit. If the wire does not come very quickly to incandescence, increase the resistance until it melts with one or two seconds' delay upon closing the circuit.

Temperature Readings:—The thermometer is inserted so that the lower end of the bulb will be about midway toward the bottom of the can. The pulley should be allowed to revolve a few minutes before reading the thermometer, in order to equalize the temperature throughout the apparatus. Take readings one minute apart for two or three intervals before igniting the charge, and continue the same for nine or ten minutes subsequent to ignition. The first three or four readings after ignition are roughly taken, but after the fourth or fifth minute the temperature should be nearly equalized, and the readings must be carefully taken in order to ascertain the exact maximum and to furnish the necessary data for making a correction for radiation. If the temperature of the water before ignition is one or two degrees below that of the room, the temperature at the end of the first minute after ignition will be something above that of the room, and radiation for that period may be considered as self-correcting. Ordinarily, the rise in temperature will continue for

about four minutes more, at which time the maximum temperature will have been reached. The radiation for this period is found as follows:— Read the fall in temperature for each minute for four minutes after the maximum has been reached. The average drop per minute represents the correction to be added to each minute preceding the maximum, except for the minute immediately following ignition. The final temperature thus corrected for radiation, minus the initial reading before ignition, represents the total rise in temperature due to the reaction in the crucible.

Calculations:—From the total rise in temperature, corrected for radiation as above indicated, subtract the correction factors for the heat due to the chemical, fuse-wire, etc., as indicated under “Correction Factors” below, and multiply the remainder by 3100. The product will be the number of British thermal units per pound of coal. (See notes (a) and (b) below.)

It is to be noted that the heat value as derived, refers to the coal in the form in which it is weighed out for making the determination. That is to say, if a coal having 5% of moisture is taken and $\frac{1}{2}$ gram of the same weighed out and dried in the oven at 212° for 1 hour, then burned in the calorimeter, the result obtained refers to the coal on the basis of 5% of moisture and not to the coal as in the oven-dry state.

To calculate values to “dry coal,” divide the number by 100% minus the per cent of moisture present. Thus, a coal having 5% moisture and indicating 11000 B. t. u. would have $11000 \div .95 = 11579$ B. t. u. on the “dry coal” basis.

Note (a), Correction Factors:—The method for obtaining the correction for radiation has already been described under Temperature Readings. The other correction components are listed for convenient reference as follows:

Electric Fuse Wire equals.....	.003°C. or .005°F.
Per cent Ash is multiplied by.....	.0025°C. or .005°F.
Per cent Sulphur is multiplied by.....	.005°C. or .010°F.
1 gram Accelerator equals.....	.150°C. or .270°F.
Hydration Factors:	
For all Bituminous Coals.....	.040°C. or .070°F.
For Black Lignites.....	.056°C. or .100°F.

Note (b):—The factor 3100 is deduced as follows: The water used plus the water equivalent of the metal in the instrument amounts to 2123.3 grams. In the reaction 73 per cent of the heat is due to combustion of the coal and 27 per cent is due to the heat of combination of CO₂ and H₂O with the chemical. If now $\frac{1}{2}$ gram of coal causes 2123.3 grams of water to rise “r” degrees, and if only 73 per cent of this is due to combustion, then $.73 \times 2123.3 \times 2 \times “r” = \text{rise in temperature which}$

would result from combustion of an equal weight (2123.3 grams) of coal. $.73 \times 2123.3 \times 2 = 3100.00$. The factor 2 is used instead of the divisor 0.5. the weight of coal taken.

To Dismantle:—Remove the thermometer, pulley and cover; then take out the can and contents entire, so that the lifting out of the cartridge will not drip water into the dry parts of the instrument. Remove the fusion cup and place it on its side in the bottom of a beaker and cover with hot water. After the fused material has dissolved, remove the cup and rinse thoroughly with hot water. Wash the face of the cap and electric terminals thoroughly. For this purpose a jet of hot water or submerging in boiling water is advisable, as the metal is thus left clean and hot, the latter facilitating the drying out of the parts. Place the parts on a radiator or near a hot plate to insure thorough drying.

Anthracites and Coke:—In the case of anthracites and coke, it is well to use 0.2 grams of benzoic acid along with the 1 gram of accelerator and $\frac{1}{2}$ gram of fuel. This substance facilitates ignition as well as the ultimate combustion. The heat resulting from the combustion of this extra 0.2 gram of benzoic acid, which is to be corrected for along with the other correction components, is 1.550° F.

EXERCISE VII.

For Petroleum Oils:—The amount of oil used for a charge should not exceed about $\frac{1}{3}$ gram; from 0.20 to 0.25 gram giving the proper combustion. The weight of oil is best obtained by means of a small light 15 c. c. weighing flask provided with perforated cork and dropping tube with common rubber bulb-cap. Weigh the flask and contents, and by means of the dropping tube discharge 20 to 30 drops of oil and re-weigh, thus obtaining the weight of oil taken by difference. Determine, by experiment, the height in the dropping tube required for the approximate amount of oil desired so as to avoid trial weighings. One full measure of chemical (sodium peroxide) and 1 gram of accelerator are first added and thoroughly shaken as already indicated. Also, to facilitate the ignition of all oils and at the same time promote the ultimate combustion, it is recommended that a small amount (0.2 gram) of benzoic acid be used as described under "Anthracites and Coke." Add the oil and benzoic acid last and mix thoroughly by shaking as already indicated and complete the process exactly as for coal.

Compute by means of the formula as follows:

Correcting as under coals for radiation, accelerator, benzoic acid and fuse-wire, and letting "r" represent the rise in temperature; then

$$\frac{\text{"r"} \times 0.73 \times 2123.3}{\text{Wt. of oil}} = \text{B. T. U. per pound of oil.}$$

EXERCISE VIII.

Gasolene, Etc.:—For gasolene, benzene and very volatile liquids, the difficulty of securing an accurate weight of the material taken is met by the following procedure: By the use of very thin-walled glass tubing of about $\frac{5}{32}$ inch in diameter, a light bulb with capillary tip may be blown of approximately the size and shape shown herewith, Fig. 19. After a little practice it is not difficult to blow such bulbs to weigh less than 0.2 gram. These may be also made from a capillary obtained by softening an ordinary piece of tubing



Fig. 19

in the flame, and drawing out the same to a filament about the size of a knitting needle. By fusing the end of such filament, bulbs of the desired size and weight may be blown. When so blown, they may be used as follows: Weigh the bulb carefully, then dipping the capillary end into the liquid and alternately warming gently and cooling the bulb a quantity of gasolene is drawn into the bulb. When about 0.2 gram is obtained, seal the capillary in the flame and weigh accurately. Add the sodium peroxide and accelerator to the fusion cup first and thoroughly mix by shaking in the usual manner. Next add 0.2 gram of benzoic acid and the bulb of gasolene. Put on the ignition top and clamp firmly in place with the screw cap. Rotate the bomb and bring it into an inverted position, shaking lightly at first to bring the bulb on top of the chemical and nearest the bottom of the fusion cup. Thus inverted shake the bomb vigorously to break the bulb. then assemble in the calorimeter in the usual manner. In calculating, a correction is necessary, in addition to those normally observed, on account of the heat of fusion due to the glass present. This amounts to 0.03° F. for each 0.1 gram of glass used in the bulb. This should be subtracted along with the correction for accelerator and fuse-wire. The corrected rise, "r," is then used in the formula as above given for petroleum.

EXERCISE IX.

Sulphur:—Where determinations for sulphur are to be made independently of the calorimetric process, a special apparatus as shown in Fig. 20 is employed. The charge consists of one measure of sodium peroxide and $\frac{1}{2}$ gram of coal. Close with the cover and screw cap and shake thoroughly. Ignite the charge by applying the flame of a Bunsen burner to the bottom of the fusion cup for a moment. Remove the flame as soon as the reaction has commenced, which will be indicated by the lower portion of

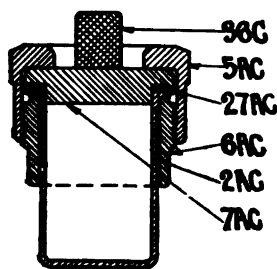

Fig. 20

the cup becoming a dull red. After the charge has ignited, the bomb may be cooled without delay by holding under the tap or submerging in water. If the cover is fitted with a rubber gasket, the cooling with water should follow very soon after the ignition. If an asbestos gasket is used, the cooling may be attended to at leisure. The use of a rubber gasket is preferred, as it does not disintegrate on washing. The dismantling and dissolving out the fusion from the cup is carried out in

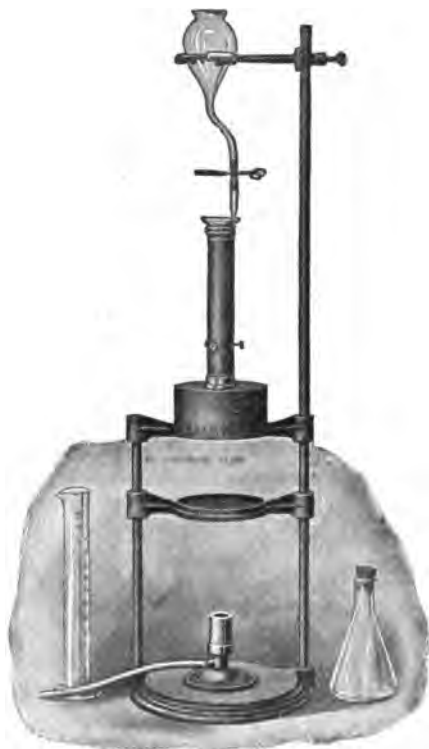

Fig. 21. Sulphur Photometer.

the usual manner as already described. The solution is neutralized with chemically pure hydrochloric acid and 1 c. c. of the concentrated (1.19 sp. g.) acid added in excess. The bulk of the solution should be about 300 c. c. From this point the sulphur as SO_3 is determined in the regular manner, either by the gravimetric or photometric process.

The Photometric Process:—Transfer the slightly acid solution to the 250 c. c. flask and make up to the mark. Mix thoroughly and measure out for analysis 50 c. c. of the solution into the cylinder G, Fig. 21, and 50 c. c. of distilled water so that the final volume shall be 100 c. c.

Transfer the 100 c. c. of solution from the cylinder to the Erlenmeyer flask E, add 0.3 to 0.5 gram of Special Barium Chloride Powder,* and without delay close the flask with the cork and shake vigorously for one or two minutes, then allow to stand at room temperature, with occasional shaking, for 15 to 20 minutes.

In reading the turbidity, the solution is shaken and a portion poured from the Erlenmeyer flask, E, into the wide mouthed dropping funnel, F. The graduated tube, A, is adjusted in the dark tube so that the rounded lower end dips well into the water in the flat bottomed dish, B, which should be about $\frac{1}{2}$ inch in depth. Adjust the flame to a height of 1 inch. This is accomplished by having the tip appear about $\frac{1}{8}$ of an inch above the edge of the metal chimney.**

By means of the pinch cock admit the turbid solution until the point of light from the candle flame, L, just disappears, the last point of light from the flame being no longer visible. Do not take account of the slightly luminous center that appears when the amount of sulphur is high and the readings are on the lower portion of the scale, say from 40 to 60 mm. Take as the end point the disappearance of the point of light. Remove the tube and read in milligrams the depth of the liquid. By means of the table or curve is shown the weight in milligrams of the sulphur present in the 100 c. c. of solution. If 50 c. c. were taken from the 250 c. c. flask, and this latter contained the fusion from a $\frac{1}{2}$ gram sample of coal, then the sulphur reading would be the weight present in $\frac{1}{10}$ gram of coal. By removal of the decimal point, therefore, one place to the right, there would be shown the weight of sulphur in one gram of coal which can then be read in parts per 100, or per cent, by placing the decimal two more places to the right. If read in milligrams each unit is then 1 per cent.

For example, if the results show a depth of 105 millimeters, there would be indicated 1.93 milligrams of sulphur present in the quantity taken, that is 0.00193 grams. Now, if $\frac{1}{5}$ of the $\frac{1}{2}$ gram of coal is represented in this amount, the reading is for $\frac{1}{10}$ gram of coal. For 1 gram of coal there would then be 0.0193 gram of sulphur, or 1.93 per cent.

If the sulphur is so great in amount as to afford too great turbidity for satisfactory reading, repeat the process, measuring out 25 c. c. of the solution and diluting with water sufficient to make a total of 100 c. c. in volume, and proceed as above outlined. After multiplying the

*The Special Barium Chloride Powder is composed of equal parts of Barium Chloride (BaCl_2) and Oxalic Acid ($\text{H}_2\text{C}_2\text{O}_4$). By trial measurement on the point of a spatula and weighing a few times, the amount of powder by bulk can be readily determined with sufficient accuracy.

**A small 3-volt tungsten bulb with current from 2 dry cells gives a more satisfactory light. The readings check with those obtained with the gas flame so that the same curve may be used.

weight of the sulphur thus indicated by 2, the conditions will be the same as indicated in the paragraph above.

In cases where the content of sulphur in the coal is so low that the reading on the tube comes above the limit of graduation, a larger quantity of the solution representing a greater amount of coal should be taken. Thus, if we take 100 c. c. of the solution, we will be taking $\frac{2}{5}$ of $\frac{1}{2}$ gram of the original coal or $\frac{1}{5}$ (.2) gram of coal. Now, the sulphur indicated on the curve will be the weight in milligrams which accompanies 0.20 gram of coal. If, therefore, we read the percentage as normally indicated and divide by 2, we will have the correct indication for the content of sulphur. For example, if the reading under these conditions shows a depth of 105 m. m. there would be indicated 1.93 milligrams of sulphur for the amount of coal taken, 0.2 grams. This would be 0.965 milligrams for 0.20 gram of coal, or 0.96 per cent.*

Special care must be taken to prevent the settling out of the precipitate. A reading can be quickly made and the contents of the tube poured back into the funnel. Readings should be repeated several times, thus keeping the mixture stirred and affording greater accuracy as to the final average taken. Before beginning, the bottom of the tube inside should be cleansed by means of a swab to insure that no film of precipitate from the previous test has settled out.

The diaphragm between the dark cell and the candle prevents moisture from forming on the bottom of the water cup. Notice should be taken, however, as to this point; and, in case of a film of moisture forming, it may be prevented by warming the water used in the cub a little above the room temperature. For the same reason be sure that no sediment has settled out on the bottom of the cup, B. Perfect alignment of the flame through the diaphragm and tube should be secured. The conditions as to strength of light, methods of reading, the end point, etc., may vary from the standards adopted in the table. Each individual may easily check his own method by making up a solution of chemically pure sulphuric acid, having 0.5438 gram per liter, which is equivalent to 0.0001 gram of sulphur per c. c. Use 15 or 20 c. c. in making the test.

Note:—In tabulating the results of coal analysis remember that the constituent percentages in the case of each condition of reference should total 100 per cent; this also excluding the factor for sulphur, which in the process of proximate analysis is a constituent part of certain components, approximately $\frac{1}{2}$ going with the volatile matter and $\frac{1}{2}$ remaining with the coke.

*Some coals, especially of the semibituminous or Pocahontas type, have a content of sulphur so low as to make it advisable in such cases to dissolve the fusion in a smaller quantity of water, so that the volume when made up shall be 100 c.c. With sulphur so low as 0.5 per cent the entire solution would be required for use with the photometer.

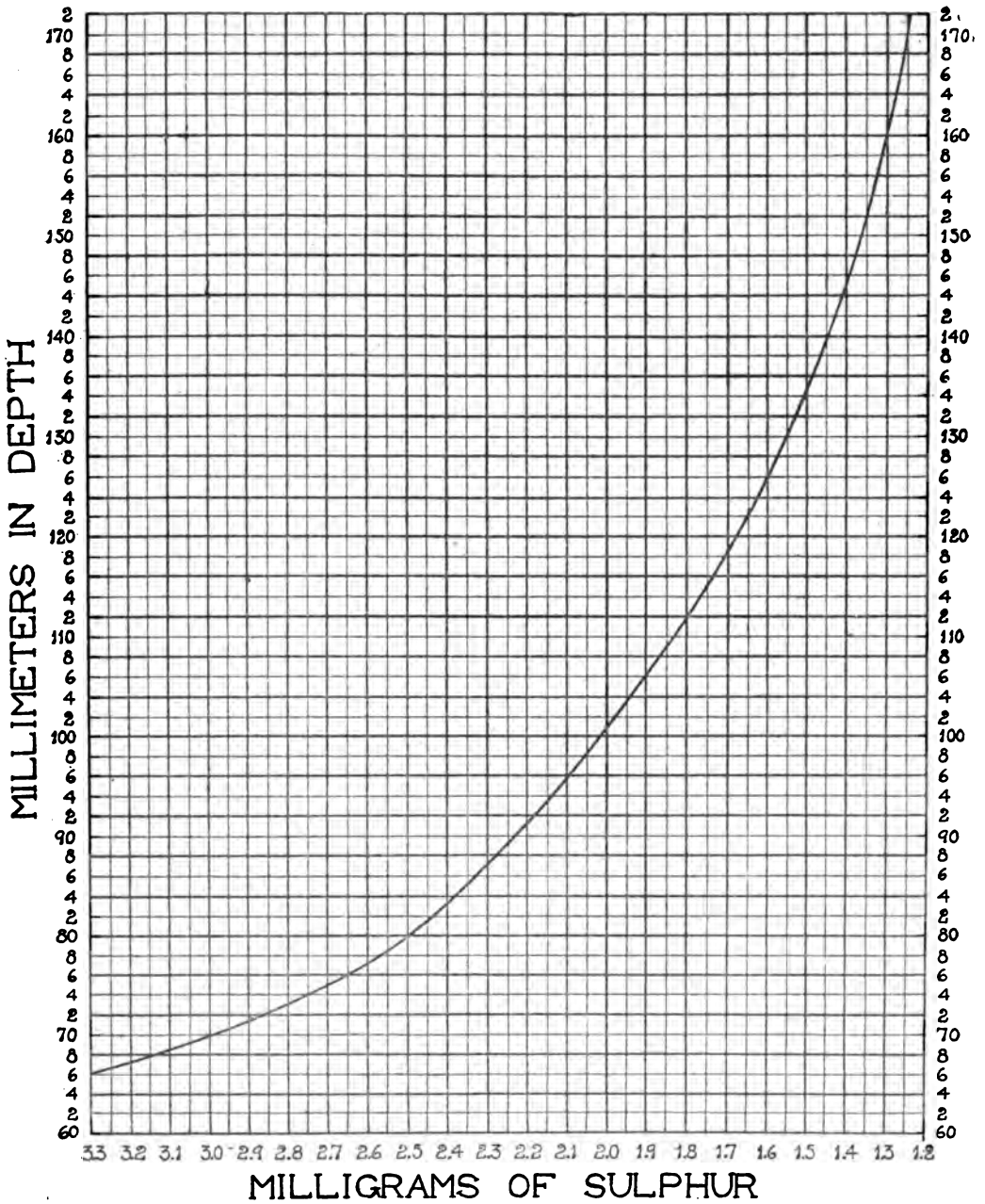

Fig. 22. Curve showing the weight of sulphur in milligrams

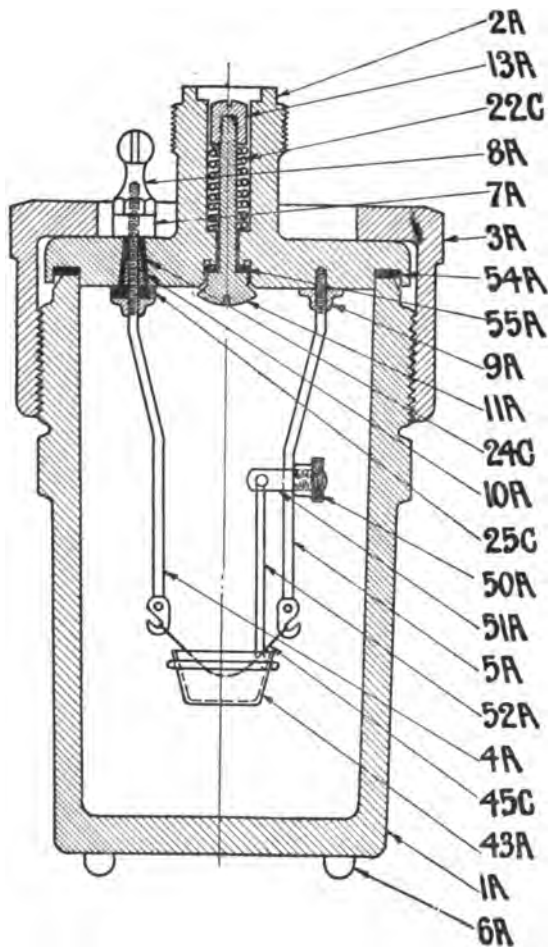

Fig. 23
Oxygen Bomb

EXERCISE X.

Heat Values by the Oxygen Bomb Calorimeter:—Figure 23 shows the arrangement of the parts of the bomb when ready for placing in the calorimeter. When the calorimeter is dismantled the double cover to the insulating chamber is supported on a ring-stand as shown in the cut, Fig. 12, Part I. This affords a convenient method of handling the stirring device and insures greater safety for the thermometer.

When the bomb is opened and made ready to receive the charge of fuel, the cap is most conveniently held on the ring-stand which accompanies the instrument. Thus supported, the fuel capsule and fuse wire are readily adjusted as shown in Fig. 24. For coal, one gram of the

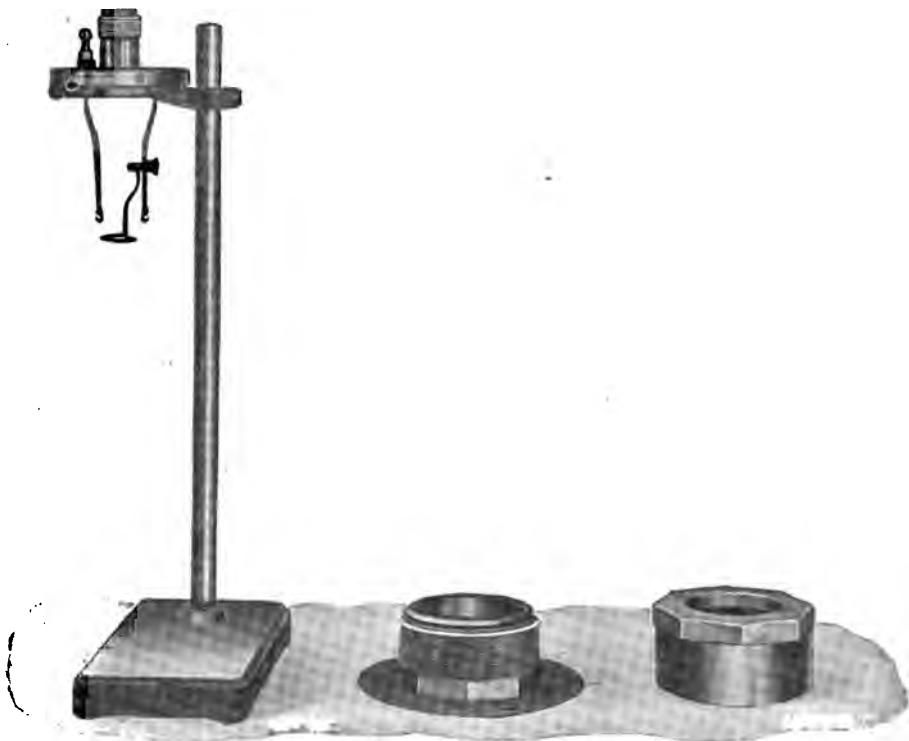

Fig. 24

Holders for Filling and Adjusting the Fuse Wire.

air-dry sample, ground to pass a 60 mesh sieve, is weighed in the capsule 43A, Fig. 23. Attach the ignition wire to the terminals, 4A and 5A, by passing one end thru the eyelet of one of the terminals so it will extend beyond the eyelet about $\frac{1}{4}$ -inch. Wrap the free wire around the terminal at the narrow portion formed by the notch, giving it three turns, binding in the free end and bending the wire finally downward in line with the terminal. Repeat the same process with the other end of the wire. The fuse wire should be about 7 cm. long. That part of the wire between the terminals should be bent into a somewhat narrow U shaped loop so that the fuse wire will not touch the sides of the capsule. Adjust the wire so that the lower part of the fuse loop will just touch the surface of the coal.

Transfer the cover to the bomb, in which a half cubic centimeter of water has been placed for taking up the acids formed in the process of combustion. The bomb should rest in the octagon holder for filling. Screw on the cap, 3A. In sealing, apply the large wrench, using good, firm pressure, though only moderate force is necessary for securing a perfect seal at the rubber gasket, 54A.

For filling with oxygen, connection is made with the flexible copper tubing and oxygen is admitted until a pressure of 25—30 atmospheres is indicated. In admitting the oxygen the needle valve next to the pressure gauge is opened slightly to avoid a sudden rush of gas. After a sufficient amount has been admitted, close the needle-valve and open the pet-cock below the gauge in order to release the oxygen under pressure in the tube and connections. The check valve, 11A—Fig. 23, automatically closes and retains the oxygen at the desired pressure.

Transfer the bomb carefully, without jarring, to the oval can which has been placed in position in the calorimeter. The long axis of the oval should be in line with the operator, that is, at right angles to the work desk. The pointer, 57A—Fig. 25, and a notch in the can directly opposite, serve as guides for correctly locating the vessel. The circular elevation in the bottom which directs the locating of the bomb should be toward the operator. Turn the bomb so that one of the faces of the octagon, rather than an angle, will be toward the operator, thus giving more room for the thermometer. Make the connection with the electric terminal, 58A, and add 2000 grams of water, preferably distilled. The temperature of the water should be 2° or 3° Fahrenheit below that of the room.

In placing the cover on the calorimeter have the thermometer toward the operator. This will bring the pulley with turbine stirrer at the back of the instrument. Bring the cover to place carefully so as to avoid striking the thermometer against the metal parts (see Fig. 25). Seat the spring clips for holding the cover firmly in place and connect the pulley with the motor. The motor is adjusted so as to give the turbine pulley a speed of about 150 revolutions per minute turning to the right or clockwise. A uniform speed throughout a determination is desirable.

By use of the telescopic lens, readings of the thermometer for the *preliminary period* are taken at one minute intervals for five minutes. At the fifth reading close the electric circuit for a second or not to exceed two seconds. Ignition of the sample should be indicated by a rise of the mercury, which becomes rapid after 20 or 30 seconds. The *combustion period* extends over 5 or 6 minutes and terminates when the maximum temperature has been reached, or when the rate of change has become uniform. The *final period* follows the combustion period. Readings are taken at minute intervals for five minutes.

OBSERVATIONS*

During the ignition period, if the temperature rise for the sample in hand is not approximately known, take thermometer readings at 40, 50 and 60 seconds after firing.

Make the following notations:

- (1) The rate of rise (r) for the preliminary period in degrees per minute.
- (2) The time (a) at which the last reading of the preliminary period is made, immediately before firing.
- (3) The time (b) when the rise of temperature has reached six-tenths of its total amount. This point can generally be determined by adding to the temperature reading at the time of firing 60 per cent of the expected temperature rise and noting the time (b) when this point is reached. If the approximate temperature rise is not known, six-tenths of the total rise as subsequently developed, when added to the temperature reading at (a), will indicate the time (b) by interpolating readings obtained at the 50, 60, and 70 second periods after firing.
- (4) The time (c) when the maximum temperature has been reached, or when the rate of change has become uniform, usually about five minutes after firing.
- (5) The rate of change (r_1) for the final period in degrees per minute.

COMPUTATIONS

Apply the corrections as indicated on the thermometer certificate for the initial (a) and final (c) readings.

Multiply the rate (r_1) by the time ($b-a$) in minutes and tenths of a minute and add the product to the corrected temperature reading at time (a).

Multiply the rate (r_2) by the time ($c-b$) and add (or subtract if the temperature was *rising* during the final period) the product to the corrected temperature reading at time (c).

The difference of the two readings thus modified to account for radiation corrections gives the total rise of temperature due to combustion.

Multiply the total rise thus found by the water equivalent of the calorimeter, the product giving the total amount of heat liberated. If the thermometer readings were in Fahrenheit degrees the product gives the heat value in B. t. u.

*See report of Committee on Methods of Coal Analysis, Journal of Industrial and Engineering Chemistry, Vol. 5, p. 517 (1913).

CORRECTIONS

The heat produced by the formation of nitric acid from the nitrogen in the oxygen and sulphuric acid from the sulphur in the combusti-

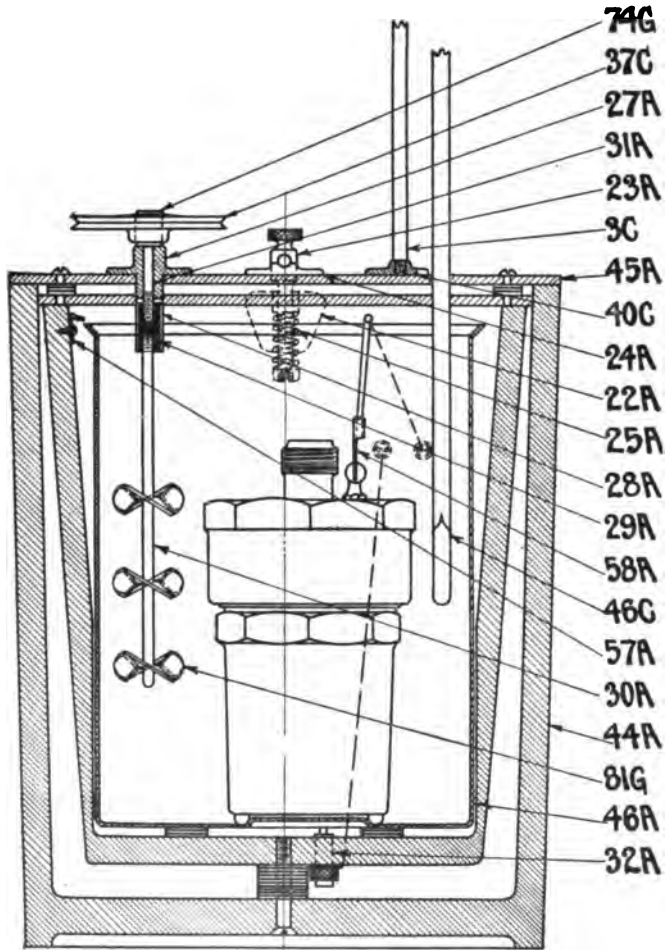

Fig. 25

Oxygen Bomb Calorimeter

ble is corrected for by washing the bomb thoroughly with distilled water after the determination is completed and titrating the washings with a solution of sodium carbonate.

Make up the sodium carbonate solution by dissolving 2.061 grams chemically pure Na_2CO_3 in one liter of distilled water. One cc=1 B. t. u. for the formation of nitric acid.

The sulphuric acid formed has produced an equivalent of heat in excess of the correction applied as for nitric acid equal to $3\frac{2}{3}$ times the sulphur content expressed in per cent.

Iron wire of No. 34 American Gauge produces heat at the rate of 4 1/2 B. t. u. for each centimeter of wire burned. A correction should, therefore, be made for the length of wire actually consumed. Subtract the unburned portion remaining on the terminals from the original length in centimeters and multiply the remainder by 4 1/2, the result is the correction in B. t. u. for the wire consumed.

Finally note that the total indicated heat as corrected for nitric acid, sulphuric acid and fuse wire refers to a quantity of fuel represented by the weight of the charge taken. If this weight were exactly 1 gram no further computation is necessary. If the weight taken varied from an even gram, the indicated B. t. u. as above derived must be divided by the weight of fuel taken.

To discharge the oxygen from the bomb, press down the valve, 13A, with the thumb to release the gas. Do not try to remove the screw cap, 3A, until after the gas pressure has been released.

Upon opening examine the interior for unburned carbon. If any is found reject the experiment.

To standardize the instrument, make a combustion using a standard substance of known heat value as pure benzoic acid. Add to the accepted heat value of the quantity taken, say 1. gram, the heat due to the combustion of the wire and the nitric acid formed. Divide the heat value thus represented by the temperature rise, corrected in the usual manner. The quotient represents the total water equivalent made up to the actual grams of water employed, 2000 plus the equivalent in water of the metal parts, etc., of the apparatus.

EXAMPLE OF COMPUTATIONS

Lab. No. 7968

Date—June 29, 1914

Weight of material burned .8 grams

Room Temp. 23.7°C.

Sulphur in coal.....4.31%

O° of Beckman Ther. 21.8°C.

Water Eqv. 2416 gram.

	Time	Temperature	
	2-11.....	.295	} $r_1 = \frac{.018}{5} = 0.0036$
	12.....	.299	
	13.....	.303	
	14.....	.307	
	15.....	.310	
(a)	16.....	.313	
	Fired		

(b)	17-12.....	1.573*	Initial temp.	0.313	Final	2.399
			Certif. Corr. —	.001	Corr. +	.009
			Corr. initial	<u>.312</u>	Final	<u>2.408</u>

	21.....	2.399	} $r_2 = \frac{.005}{5} = 0.001$
	22.....	2.398	
	23.....	2.397	
	24.....	2.397	
	25.....	2.395	
	26.....	2.394	

(b - a) × r ₁	= 1.12 × .0036.....	0.004	
(c - b) × r ₂	= 3.48 × .001.....		0.003
		<u>316</u>	<u>2.411</u>
			<u>.316</u>
			2.095
Setting Corr.		+	0.001
Stem “		+	<u>0.001</u>
Corrected rise.....			2.097

Total Calories = 2416 × 2.097 = 5066.4

Acidity titration = 27.2 Cal.

Corr. for wire = 18.4 “

Sulphur Corr. = 44.8 “ 90.4

Calories from .8 gram = 4976.

Calories per gram = 6620.

*The initial temperature is 0.313
60% of the expected rise is 1.260

The time to observe then is 1.573

Note a:—For anthracite coal a thin pad of asbestos felt should be formed on the inside of the capsule. Take a small amount of asbestos pulp, squeeze out the water and form a felt on the bottom and sides of the capsule, then dry and ignite. This will prevent the lowering of the temperature below the ignition point before combustion is complete.

Note b:—To insure against loss of oxygen thru leakage it is well to keep the needle-valve between the gauge and the oxygen cylinder and also the valve on top of the cylinder closed when not drawing out oxygen. For filling the bomb, open first the cylinder valve slightly, then open the needle-valve gradually, regulating the flow by noting the gauge indicator.

Note c:—Do not attempt to displace the air in the bomb with oxygen before filling. A certain amount of nitrogen is necessary for the complete oxidation of the sulphur. (See Vol. 6., p, 812, Journal of Industrial and Engineering Chemistry).

CHAPTER VIII

ULTIMATE ANALYSIS OF COAL

Total Carbon Determination:—The percentage of total carbon in the coal used is a necessary factor in determining the heat losses in the

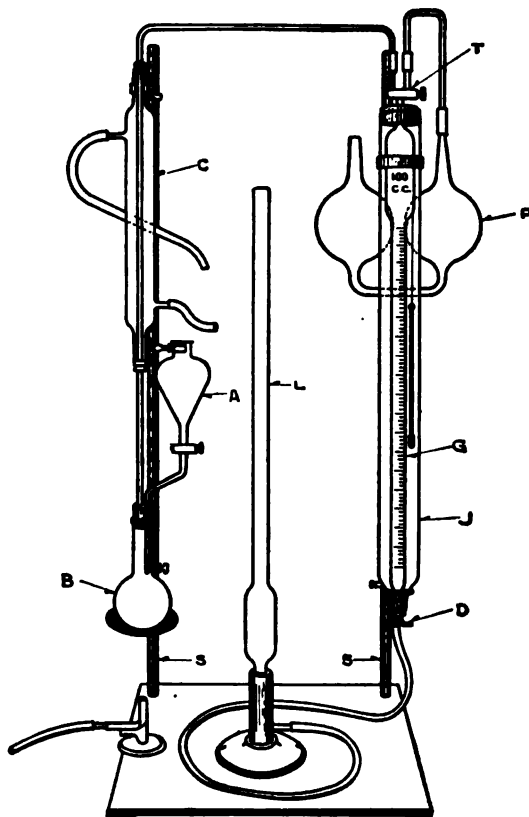

FIG. 26

flue gases as already indicated in the calculations on pages 73 to 76 inclusive. This value may be obtained by making an ultimate analysis

which consists essentially in burning a sample of the coal in a current of oxygen, absorbing the CO_2 formed in a solution of potassium hydroxide, and obtaining the amount of CO_2 formed by direct weighing. A more convenient method makes use of the fusion resulting from the calorimetric determination using sodium peroxide. As a result of the reaction, all of the carbon of the coal is present in the fusion as sodium carbonate, Na_2CO_3 . By treating with acid, therefore, in a suitable apparatus, the CO_2 is delivered in a form to be measured by volume as shown in Fig. 26.

The apparatus should be located on a laboratory desk or table where an even temperature can be maintained.

Fill the jacketing tube "J" with water slightly acidulated to keep it clear. Fill the leveling tube "L" with water that has had two or three c.c. of sulphuric acid added. A few drops of methyl-orange in the leveling tube will impart a color to the water, greatly facilitating the readings.

Connect the inlet "D" with air pressure and adjust so that two or three bubbles of air per second will enter the jacketing water. This is for the purpose of keeping the temperature of the water equalized throughout a determination. By reading the thermometer hung in the water the temperature of the gas under observation is obtained.

The operation is as follows:—The large double pipette "P" is half filled with 40 per cent solution of caustic potash, or such as is ordinarily used for the absorption of CO_2 gas. By turning the three-way cock "T" to connect with the pipette "P" and lowering the leveling tube "L" the liquid in "P" is brought into the right hand bulb and made to rise in the capillary tube to the mark on the right limb of the capillary. The three-way cock is now closed to the pipette bulb and opened to the tube running to the flask "B". By raising the leveling tube "L" the liquid in the burette "G" is made to rise to the three-way cock "T", thus completely filling the burette. The three-way cock is now closed to retain the liquid in the burette at the zero point, till evolution of the gas is begun.

The cup containing the fused material from a calorimetric determination is placed on its side in the bottom of a small beaker and covered with hot water that has been boiling for 5 or 10 minutes. When the fusion is dissolved remove the cup, rinsing it well, and pour the solution directly into the flask "B". Wash out the beaker thoroughly with hot water and pour the washings in with the main portion. Connect with the funnel tube "A" and bring the ring support with wire gauze in place under the flask. Open the stop cock at the lower end of the funnel and boil the contents of the flask for 3 or 4 minutes. Remove the flame and at once close the funnel cock. In this way the oxygen from the

sodium peroxide will be driven off together with the air in the flask. Also, since the three-way cock "T" is closed there will be a partial vacuum in the flask.

With the cock to the funnel tube "A" closed, enough acid is added to "A" to completely neutralize the alkaline solution in "B" and leave a distinct excess of acid. Either hydrochloric or sulphuric acid may be used. Thirty cubic centimeters of concentrated hydrochloric acid, or 15 c.c. of a solution of concentrated sulphuric acid and water in the proportion of 1:1 will be found sufficient.

To operate, lower the leveling tube "L", open the three-way cock "T" to the tube connecting with the flask "B" and admit acid drop by drop from the funnel "A". Meantime the circulating water for the condenser "C" should be turned on.

When the evolution of gas has about reached the capacity of the graduated burette "G", the acid is shut off, the three-way cock "T" closed and a reading of the volume of the gas carefully taken by bringing the two surfaces of liquid in the leveling tube and burette exactly on a level. Read also the temperature of the jacketing water and note the barometric pressure. The cock "T" is now opened to the capillary and the gas volume forced completely over into the bulb "P" where it is held by closing the cock "T". Here it is left for complete absorption of the CO_2 . The cock "T" may be again opened to connect with the flask "B", the liquid in the burette "G" being at the zero point as before. The apparatus is now ready for a second evolution and measurement of a gas volume.

A second reading is similarly taken and the volume driven over into "P" as before, along with the former volume.

Finally heat is added to the flask "B" and after a few minutes boiling, hot water is added through the funnel "A", until the entire space in "B" to the three-way cock "T" is filled. The flame of course being removed.

The various readings should be so adjusted that this final process will produce a volume sufficiently large to bring the same down upon the graduated portion of the burette for reading.

Finally the residual gas in "P", after the complete absorption of the CO_2 , is returned to the burette "G" and the volume read. The difference between this volume and the total of the several volumes is the total carbon dioxide present in the fusion.

By referring to Table XIX there is found at the observed temperature and pressure the weight in milligrams of carbon in one cubic centimeter of CO_2 gas.* Multiply this weight by the number of cubic centi-

*See also "The Weight of Carbon Dioxide with a Table of Calculated Values." S. W. Parr, Journal American Chemical Society, Vol. XXI, p. 237, 1909.

TABLE XIX

**WEIGHT OF CARBON
IN MILLIGRAMS PER CUBIC CENTIMETER OF CO₂**

CALCULATED FROM 1976 = WT. OF CO₂ AT 41° LATITUDE.

CORRECTED FOR WATER VAPOR AND BAROMETER - GLASS SCALE

	720	722	724	726	728	730	732	734	736	740	742	744
9	4851	4864	4878	4891	4906	4919	4933	4947	4960	4974	4987	5001
10	4859	4872	4886	4899	4913	4926	4939	4952	4965	4978	4991	5004
11	4867	4880	4893	4906	4919	4932	4945	4958	4971	4984	4997	5010
12	4875	4888	4901	4914	4927	4940	4953	4966	4979	4992	5005	5018
13	4883	4896	4909	4922	4935	4948	4961	4974	4987	5000	5013	5026
14	4891	4904	4917	4930	4943	4956	4969	4982	4995	5008	5021	5034
15	4899	4912	4925	4938	4951	4964	4977	4990	5003	5016	5029	5042
16	4907	4920	4933	4946	4959	4972	4985	4998	5011	5024	5037	5050
17	4915	4928	4941	4954	4967	4980	4993	5006	5019	5032	5045	5058
18	4923	4936	4949	4962	4975	4988	5001	5014	5027	5040	5053	5066
19	4931	4944	4957	4970	4983	4996	5009	5022	5035	5048	5061	5074
20	4939	4952	4965	4978	4991	5004	5017	5030	5043	5056	5069	5082
21	4947	4960	4973	4986	4999	5012	5025	5038	5051	5064	5077	5090
22	4955	4968	4981	4994	5007	5020	5033	5046	5059	5072	5085	5098
23	4963	4976	4989	5002	5015	5028	5041	5054	5067	5080	5093	5106
24	4971	4984	4997	5010	5023	5036	5049	5062	5075	5088	5101	5114
25	4979	4992	5005	5018	5031	5044	5057	5070	5083	5096	5109	5122
26	4987	5000	5013	5026	5039	5052	5065	5078	5091	5104	5117	5130
27	4995	5008	5021	5034	5047	5060	5073	5086	5099	5112	5125	5138
28	5003	5016	5029	5042	5055	5068	5081	5094	5107	5120	5133	5146
29	5011	5024	5037	5050	5063	5076	5089	5102	5115	5128	5141	5154
30	5019	5032	5045	5058	5071	5084	5097	5110	5123	5136	5149	5162

	746	748	750	752	754	756	760	762	764	766	768	770
9	5029	5041	5055	5069	5083	5096	5110	5124	5137	5151	5165	5178
10	5037	5049	5063	5077	5090	5104	5118	5132	5145	5159	5173	5186
11	5045	5057	5071	5085	5098	5112	5126	5139	5153	5167	5180	5194
12	5053	5065	5079	5093	5106	5120	5134	5147	5161	5175	5188	5202
13	5061	5073	5087	5101	5114	5128	5141	5155	5169	5182	5196	5210
14	5069	5081	5095	5109	5122	5136	5149	5163	5177	5190	5204	5218
15	5077	5089	5103	5117	5130	5144	5157	5171	5184	5198	5211	5225
16	5085	5097	5111	5125	5138	5152	5165	5179	5192	5206	5219	5233
17	5093	5105	5119	5132	5146	5159	5173	5186	5200	5213	5227	5240
18	5101	5113	5127	5140	5154	5167	5181	5194	5208	5221	5235	5248
19	5109	5121	5135	5148	5162	5175	5189	5202	5216	5229	5243	5256
20	5117	5129	5143	5156	5170	5183	5197	5210	5224	5237	5251	5264
21	5125	5137	5151	5164	5178	5191	5205	5218	5232	5245	5259	5272
22	5133	5145	5159	5172	5186	5199	5213	5226	5240	5253	5267	5280
23	5141	5153	5167	5180	5194	5207	5221	5234	5248	5261	5275	5288
24	5149	5161	5175	5188	5202	5215	5229	5242	5256	5269	5283	5296
25	5157	5169	5183	5196	5210	5223	5237	5250	5264	5277	5291	5304
26	5165	5177	5191	5204	5218	5231	5245	5258	5272	5285	5299	5312
27	5173	5185	5199	5212	5226	5239	5253	5266	5280	5293	5307	5320
28	5181	5193	5207	5220	5234	5247	5261	5274	5288	5301	5315	5328
29	5189	5201	5215	5228	5242	5255	5269	5282	5296	5309	5323	5336
30	5197	5209	5223	5236	5250	5263	5277	5290	5304	5317	5331	5344

meters obtained in the above operation and the product equals the weight in milligrams of pure carbon. From this should be subtracted the weight of carbon found by running a blank in exactly the same manner, using one measure of the sodium peroxide instead of the fusion.

After subtracting the blank, the carbon remaining represents the total carbon present in the fuel. Divide this number by the weight of fuel taken and multiply by 100. The product is the per cent of carbon present in the sample taken.

Note: The fusion and alkaline solution should be covered and kept free from circulating air, so as to avoid absorption of CO.

Hydrogen:—In the calculations for deriving a heat balance, the engineer requires the factor for the total hydrogen in the coal used. The hydrogen present is considered as combined in two different ways. In one, the hydrogen is “disposable” or “available” for combustion. In the other it is supposed to be joined with oxygen to form H₂O and when thus combined is not available for the production of heat. The available hydrogen may be derived as follows: If we let C represent the percentage of total carbon, then 14544C will equal the heat value for that constituent. To this add the heat value of the sulphur present, 4500S. The remainder of the heat is due to the combustion of hydrogen. Hence, with a value for hydrogen of 62,100 the percentage of available hydrogen, H, will be represented by the expression:—

$$H = \frac{\text{B.t.u} - (14544C + 4500S)}{62,000}$$

The hydrogen not available or considered to be in combination with oxygen is estimated as $\frac{1}{8}$ of the oxygen or O/8 as in Dulong's formula. There is required, therefore, the percentage of oxygen and this is determined by difference. That is, if we subtract from 100 the values for ash, sulphur, total carbon, available hydrogen, and nitrogen, the difference will be the non-available hydrogen and oxygen present in the ratio of H₂ : O. Hence $\frac{1}{9}$ of this difference is H₂ and $\frac{8}{9}$ is the oxygen percentage. That is, the per cent of chemically combined water is represented by the formula:—

$$\text{H}_2\text{O} = 100 - (\text{A} + \text{S} + \text{C} + \text{available H} + \text{N})$$

The only undetermined factor in the above expression is that for nitrogen. It may be determined directly by the Kjeldahl method, or, for purposes of calculating a heat balance it is quite sufficiently accurate to assume a value of 1 per cent for nitrogen, since the amount present in bituminous coals varies only within relatively narrow limits, say from 0.75 to 1.50 per cent.

CHAPTER IX

THE ANALYSIS OF FLUE GASES

Reagents:—The analyses to be made in this course will be performed with what is known as the “Orsat apparatus.” This is made of a jacketed 100 c.c. gas burette and leveling bottle permanently connected by a capillary tube having four side arms to three pipettes and to the open air. The end of the capillary tube extends outside the case for convenience in taking a sample of gas. The pipettes are provided with reagents, as follows:

1. *Potassium Hydroxide*, for absorption of carbon dioxide, CO_2 . Strength of solution, 50%. One c.c. absorbs 40 c.c. of carbon dioxide.

2. *Potassium Pyrogallate*, for absorption of oxygen, O_2 . Dissolve 5 grams of pyrogallic acid in 20 c.c. of water and pour into the proper pipette. Next dissolve 120 grams (approximately) of potassium hydroxide (KOH), in 80 c.c. of water and add to the same pipette. Keep protected from the air. One c.c. absorbs 2 c.c. of oxygen.

3. *Cuprous Chloride*, for absorption of carbon monoxide, CO . This may be prepared in two ways: (1) by keeping a bottle full of hydrochloric acid (1.10 sp. gr.) having copper oxide in the bottom and much copper wire in it, or, (2) shake together in a closed flask 200 grams commercial cuprous chloride and a solution containing 250 grams ammonium chloride in 750 c.c. of water. Add enough ammonium hydroxide to bring the cuprous chloride completely into solution. This will require about 1 volume of ammonium hydroxide solution (sp. gr. 0.90) to 4 volumes of the solution. Keep protected from air in a bottle, which has suspended in it a spiral of copper extending from top to bottom of the bottle. 1 c.c. of this solution will absorb 16 c.c. carbon monoxide, but it is best to renew the solution after it has absorbed its own volume of carbon monoxide, since the compound formed readily dissociates in concentrated solution, giving off gaseous carbon monoxide.

These solutions may be protected from the air by covering the surface in the outside arm of the pipette with a layer of kerosene. Great care must be exercised, however, to keep the kerosene out of the absorption bulb of the pipette, otherwise the kerosene vapors will increase the volume of the gas residue, and thus spoil the determination.

EXERCISE I.

Analysis of Atmospheric Air:—Adjust the reagent in each pipette by drawing the solution up into the capillary tube to the mark just below the rubber connection. Fill the jacketed measuring burette with water out to the end of the capillary tube, then draw in a little over 100

c.c. of air by opening the outer vent and lowering the leveling bottle. Next, slowly raise the leveling bottle until the meniscus gives a reading of exactly zero, and the level of the water in the burette is just equal to that in the leveling bottle.

Oxygen.—Close the pinch cocks on all vents and open the one on the second pipette, the one containing potassium pyrogallate; now raise the leveling tube slowly, thus forcing the air into the pipette. When the water has reached the 100 c.c. mark on the burette, shut the pinch cock and allow to stand for five minutes. Now open the cock and run the gas back into the burette by lowering the leveling bottle. Watch the surface of the pyrogallate solution, and as it approaches the mark slow up the flow of gas—by careful manipulation of the leveling bottle the solution can be brought just to the mark and then shut off, giving much more delicate adjustment than can be obtained by manipulation of the pinch cock alone. It is very important that none of these solutions get above the pinch cock, as the potassium hydroxide in them interferes with the carbon dioxide determinations in subsequent samples.

Repeat the absorption for 3 minutes and read again. The contraction in volume is due to absorption of oxygen. Calculate the percentage on the sample taken.

EXERCISE II.

Respired Air.—The apparatus should be in adjustment after the preceding experiment. Take a long breath and hold in the lungs for some time, then blow it into one of the rubber balloons. Attach this to the outer vent of the apparatus and draw in a sample of 110 c.c. as before. Now close this pinch cock and open the one at right angle, to the air; then, by raising the leveling bottle slowly, bring the surface of the water to the zero mark and close the cork opening to the air.

A. *Carbon dioxide*. Always absorb the carbon dioxide first bringing the gas into the first or potassium hydroxide pipette. Allow it to stand for 5 minutes and repeat for 3 minutes. The contraction is due to carbon dioxide—determine its percentage.

B. *Oxygen*. Determine oxygen as in the case of atmospheric air. The difference between the total contraction and the first one is due to oxygen. Compute the percentage.

C. *Nitrogen*. This is determined by difference.

$$100 \text{ o/o} - (\text{o/o CO}_2 + \text{o/o O}_2) = \text{o/o N}_2$$

EXERCISE III.

Flue Gas.—All determinations of the constituents of flue gas are carried out as described in Exercise II.

Carbon Monoxide is determined after oxygen by means of the third

pipette, allowing the gas to stand for 8 minutes. In calculating nitrogen this is of course taken into consideration.

Analyze one sample of atmospheric air, two samples of respired air and two of flue gas.

Record on the blank attached to the Orsat apparatus the volumes of gases absorbed so that the strength of any solution can be determined at any time.

CHAPTER X

OIL EXAMINATION

EXERCISE I.

Identification as to Origin:—Weigh carefully a No. 2 beaker and add 10 gms. of oil, then 75 c.c. of 6 per cent alcoholic potash solution. Evaporate on the water bath, stirring well, until all alcohol is removed. Take up the residue with 50 to 75 c. c. of water and transfer to a separatory funnel. Add about 75 c.c. of petroleum ether, rinsing the beaker with it and transferring all washings to the funnel. (Keep the ether away from a lamp).

Shake well and let stand over night. Draw off the lower solution, stopping the flow when the line of separation reaches the top of the stop cock. Add another portion of water, shake up again until any soap that may cling to the funnel is washed off, and allow to settle. Draw off as before, this time getting all the water solution into the beaker. Heat this solution on the water bath for 15-20 minutes, or until the odor of the petroleum ether is gone. Cool and make slightly acid with dilute sulphuric acid. If there is any soap present it will be decomposed, yielding free fatty acids which rise like oil or curd to the top of the solution. Weigh carefully about 5 grams of pure white beeswax and add to the beaker, melt the whole and allow to cool. When cold, remove the cake of wax, dry between filter papers, place in desiccator, and weigh in half an hour. The increase in the weight of wax represents the fatty acids from vegetable or animal oils in the sample taken. The amount of oil corresponding to the fatty acid will be represented approximately by multiplying the weight obtained by 1.04. Calculate the percentage of vegetable and animal oils in the original sample.

Any petroleum oil present will dissolve in the upper layer of ether, imparting a color to it.

EXERCISE II.

Specific Gravity:—The specific gravity of oils may be taken with a pycnometer or with a specific gravity hydrometer. The oil should be

warmed sufficiently to allow free movement of the instrument. The temperature must also be read and corrected for. See table 2 of the Appendix.

Where available, the most accurate method is that of the Westphal balance, where a correction for temperature may also be necessary. Consult the Appendix for a table of specific gravities of standard oils. In trying to identify an oil by its specific gravity, however, the analysis under Exercise I must be taken into account, for many mixtures of cheap oils are made to imitate some of the more expensive varieties.

EXERCISE III.

Viscosity:—This property is often confounded with specific gravity. The one is the time taken for a given quantity to flow through an orifice as compared with water, the other is the weight of a given volume as compared with the same volume of water. In the event that a standard viscosimeter is not available, a pipette graduated to deliver 100 c.c. of water from the bulb alone in 34 seconds may be used as a standard.

Take a 100 c.c. pipette, fill with water and note the time required for the water to empty from the *bulb alone*. Repeat once. Now fill to the top of the bulb with oil and empty in exactly the same way. Note the temperature of the oil—it should be 60 degrees F. Divide the time for the oil to run by that required for the water—the quotient is the viscosity number.

EXERCISE IV.

Flash and Fire Test:—Place the oil to be tested in a cup, or iron crucible, if a standard tester is not available. Place on a sand bath and suspend a thermometer from a ring so that the bulb is completely immersed but does not touch the bottom of the oil cup. Apply heat, but do not have the temperature rise faster than 2°F. per minute. Keep partially covered with a split glass. Test by wafting a tiny flame over the surface of the oil once a minute. The tip for this flame may be made by taking a wash bottle tip and inserting it in the end of the gas tubing.

For lubricating purposes oils should not flash under 250°F.

In testing kerosene and ordinary illuminating oils, the heat is raised further until the gas evolved from the surface of the oil not only flashes momentarily, but burns continuously. The first temperature is the "flash point," the second the "flame point" or "fire test." The most usual flash point required for kerosene is 110°F. The flame point is 20 degrees higher.

On the same oil an open tester will give a reading about 10 per cent higher than a closed tester.

EXERCISE V.

Acid Test:—Obtain 2 oz. (60 c.c.) of alcohol from the storeroom. Add 2 or 3 drops of phenolphthalein and run in slowly $N/_{10}$ potassium hydroxide solution to obtain a very faint pink tinge. Now add 10 c.c. of the oil. If this is thick, take a clean beaker, weigh and run in about 10 c.c. of the oil and reweigh; divide by the specific gravity, getting the volume. Now add the alcohol to this and heat up to $100^{\circ}F$. Titrate with $N/_{10}$ potassium hydroxide to a permanent pink, stirring well after each addition.

If more or less than 10 c.c. have been used, calculate how much would have been required for 10 c.c. and call this the "acid number."

EXERCISE VI.

Maumene's Test:—Weigh the beaker and introduce as nearly as possible 50 grams of the oil. Introduce a thermometer, and while stirring vigorously add 10 c.c. c.p. concentrated sulphuric acid. Note carefully the rise in temperature.

Petroleum oils rise only slightly, unsaturated vegetable and animal oils give a higher rise in temperature.

Consult table 5 in the Appendix on Maumene's test and a table of the oils commonly used. Report the rise as Maumene's Test.

APPENDIX

. TABLE 1
INTERNATIONAL ATOMIC WEIGHTS

	Symbol.	Atomic weight		Symbol.	Atomic weight
Aluminum.....	Al	27.1	Neodymium.....	Nd	144.3
Antimony.....	Sb	120.2	Neon.....	Ne	20.2
Argon.....	A	39.88	Nickel.....	Ni	58.68
Arsenic.....	As	74.96	Niton (Radium		
Barium.....	Ba	137.37	emanation).....	Nt	22.4
Bismuth.....	Bi	208.0	Nitrogen.....	Os	190.9
Boron.....	B	11.0	Osmium.....	O	16.00
Bromine.....	Br	79.92	Oxygen.....	Pd	106.7
Cadmium.....	Cd	112.40	Palladium.....	P	31.04
Caesium.....	Cs	132.81	Phosphorus.....	Pt	195.2
Calcium.....	Ca	40.09	Platinum.....	K	39.10
Carbon.....	C	12.00	Potassium.....	Pr	140.6
Cerium.....	Ce	140.25	Praseodymium.....	Ra	226.0
Chlorine.....	Cl	35.46	Radium.....	Rh	102.9
Chromium.....	Cr	52.0	Rhodium.....	Rb	85.45
Cobalt.....	Co	58.97	Rubidium.....	Ru	101.7
Columbium.....	Cb	93.5	Ruthenium.....	Sa	150.4
Copper.....	Cu	63.57	Samarium.....	Sc	44.1
Dysprosium.....	Dy	162.5	Scandium.....	Se	79.2
Erbium.....	Er	167.7	Selenium.....	Si	28.3
Europium.....	Eu	152.0	Silicon.....	Ag	107.88
Fluorine.....	F	19.0	Silver.....	Pt	232.42
Gadolinium.....	Gd	157.3	Sodium.....	Nq	
Gallium.....	Ga	69.9	Strontium.....	Sr	87.63
Germanium.....	Ge	72.5	Sulphur.....	S	32.07
Glucinum.....	Gl	9.1	Tantalum.....	Ta	181.5
Gold.....	Au	197.2	Tellurium.....	Te	127.5
Helium.....	He	3.99	Terbium.....	Tb	159.2
Holmium.....	Ho	163.5	Thallium.....	Tl	204.0
Hydrogen.....	H	1.008	Thorium.....	Th	232.40
Indium.....	In	114.8	Thulium.....	Tm	168.5
Iodine.....	I	126.92	Tin.....	Sn	119.0
Iridium.....	Ir	193.1	Titanium.....	Ti	48.1
Iron.....	Fe	55.84	Tungsten.....	W	184.0
Krypton.....	Kr	82.92	Uranium.....	U	238.5
Lanthanum.....	La	139.0	Vanadium.....	V	51.0
Lead.....	Pb	207.10	Xenon.....	Xe	130.2
Lithium.....	Li	6.94	Ytterbium		
Lutecium.....	Lu	174.0	(Neoytterbium). —	Yb	173.0
Magnesium.....	Mg	24.32	Yttrium.....	Yt	89.0
Manganese.....	Mn	54.93	Zinc.....	Zn	65.37
Mercury.....	Hg	200.6	Zirconium.....	Zr	90.6
Molybdenum.....	Mo	96.0			

TABLE 2

Table for Calculating the Specific Gravity of Oils at 15.5° C.

C. H. Wright, Jour. Soc. Chem. Ind. 26, 513.

Example: A=sp. gr. at 20° Ax1.00319=sp. gr. at 15.5° C.

Tem- pera- ture. C°	Factor	Tem- pera- ture C°	Factor,	Tem- pera- ture. C°	Factor,	Tem- pera- ture. C°	Factor,
10	0.99612	14	0.99894	18	1.00177	22	1.00462
11	0.99683	15	0.99965	19	1.00248	23	1.00534
12	0.99782	16	1.00935	20	1.00319	24	1.00605
13	0.99823	17	1.00106	21	1.00391	25	1.00677

TABLE 3

REPRESENTATIVE SAMPLES OF LUBRICATING OILS

By Albert F. Seeker,

From Van Nostrand's Chemical Annual.

Name,	Sp. Gr. 60° F	Flash Test °F	Fire Test °F	Cold Test °F	Saponifi- able Matter	Ash	Acidity or alka- linity.
Air Compressor oil	0.8857	455	525	25	trace,	none,	neutral,
Air Compressor oil	0.8654	410	460	-2	none,	none,	neutral,
Car oil	0.8824	354	400	5	none,	none,	neutral,
Cutting oil	0.6036	345	425	31	82.9%	none,	1.16%
Cylinder oil	0.8921	535	600	60	20%	trace,	neutral,
Cylinder oil	0.9020	545	600	31	2.4%	none,	neutral,
Cylinder oil	0.8993	590	600	—	none,	0.06%	neutral,
Cylinder oil	0.8992	555	600	—	none,	0.08%	neutral,
Engine oil	0.9163	430	480	27	1.5%	trace,	neutral,
Engine oil	0.8845	360	415	5	10%	none,	0.05%
Engine oil	0.8970	400	465	3	none,	none,	neutral,
Engine oil	0.8810	405	470	14	none,	0.02%	neutral,
150° Fire test oil.....	0.7864	140	180	—	none,	none,	neutral,
150° Fire test oil.....	0.8206	266	300	32	none,	none,	neutral,
High speed engine oil.....	0.9152	400	465	5	17.2%	0.06%	1.09%
High speed engine oil.....	0.9149	400	475	3	15.3%	0.04%	1.06%
Ice machine oil.....	0.8941	430	495	-4	none,	0.13%	neutral,
Machine oil	0.8689	420	480	0	trace,	none,	neutral,
Marine engine oil.....	0.8812	405	440	17	none,	trace,	neutral,
Marine engine oil.....	0.8765	435	500	5	none,	0.05%	neutral,
Marine engine oil.....	0.9090	405	464	0	12.0%	0.15%	0.75%
Marine engine oil.....	0.9054	400	470	9	9.0%	0.11%	0.50%
Screw cutting oil	0.9002	380	425	15	25%	none,	1.02%
Transformer oil.....	0.8646	365	430	2	none,	none,	neutral,

	PAGE
Feldspar, Decomposition of	7
Fixed Carbon	48
Determination of	96
Flue Gas	71
Analysis of	119
Calculation of volumes and weights.....	72, 73
Loss of heat	74
Ratio of air entering to air used.....	73
Solutions for analysis of	120
Foaming ingredients	10
Fuel	27
Analysis	31
Production	29
Ratios	30
Resources	29
Types	27, 28
Gypsum, Solubility of	7
Hardness	87
Negative	88
Permanent	87
Total	88
Illinois Coals	59
Composition of	60
Lime, Use of	13
Hydrated	15
Impurity allowed for	15
Solubility of	15
Use of in water treatment.....	15
Lubricants	76, 77
Methods for testing	78, 122, 123
Mineral constituents of water	5
Analysis	85-92
Characteristics	6
Source	5
Moisture in Coal. Importance of Control.....	38
Determination of	94, 95
Loss in sampling	38
Oils	77
Analysis of	122
Specific gravity	122
Viscosity	123
Sampling of Coal	32-43
Amount required	33
Ash variations	36
Car lots	38
Care, material	33
Commercial samples	32
Composite	39
Face samples	32
Grinder for	34
Hand samples	32
Mechanical sampling	40
Moisture control	38, 43
Sizes	34

